

## Compaq StorageWorks ESL9326SL Library Configuration Guide

ESL9326SL  
0 to 16 drives  
326 slots

ESL9326SL Enterprise Library	
234488-B21	ESL9326 LVD 0 DRV
234615-B21	ESL9326SL LVD 6 SDLT 110/220 DRV
234615-B22	ESL9326SL LVD 8 SDLT 110/220 DRV
234615-B26	ESL9326SL LVD 16 SDLT 110/220 DRV
229909-B21	ESL9000 6 slot magazine
221249-B21	LVD Extender kit (required for SCSI cable length exceeding 10 meters between library and HBA)

Modular Data Router	
163083-B21	MDR (1 FC x 2 LVD SCSI)
218241-B21	MDR (2 FC x 4 LVD SCSI)

compaq.com/products/storageworks/adapters.html

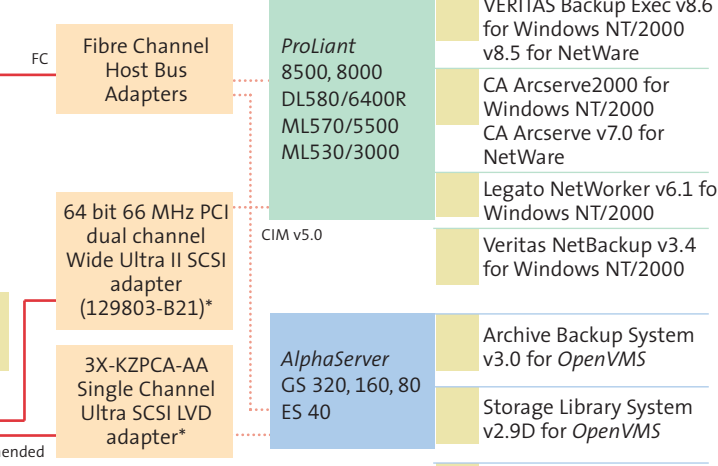

\* Note: maximum two drives per SCSI Channel recommended

### Cable Options

SCSI Cable, VHDCI/Wide, 6 ft	341176-B21
SCSI Cable, VHDCI/Wide, 12 ft	341177-B21
SCSI Cable, VHDCI/Wide, 10 m	201160-B21
SCSI Cable, VHDCI/Wide, 20 m	201160-B23
Wide Differential SCSI cable, 10 m	328215-002
Wide Differential SCSI cable, 20 m	328215-004

Check the cable-adapter matrix for tape libraries on <ftp://ftp.compaq.com/pub/products/storageworks/tape-and-optical-storage/adapter-cable-matrix.pdf>

### Power Cord

ESL9326D C-KIT, SE Asia/India	146210-AR1
ESL9326D C-KIT, Central Europe	146210-021
ESL9326D C-KIT, Aus/China/NZL	146210-011
ESL9326D C-KIT, Switzerland	146210-111
ESL9326D C-KIT, UK/Hong Kong	146210-031
ESL9326D C-KIT, Italy	146210-061
ESL9326D C-KIT, Denmark	146210-081
ESL9326D C-KIT, Japan	146210-291

US/Canada/Mexico power cord included

## Compaq StorageWorks ESL9198SL Library Configuration Guide

ESL9198SL  
0 to 8 drives  
198 slots

ESL9198SL Enterprise Library	
194993-B21	ESL9198SL LVD 0 drives
234618-B21	ESL9198SL LVD 4 SDLT 110/220 DRV
234618-B22	ESL9198SL LVD 8 SDLT 110/220 DRV
229909-B21	ESL9000 6 slot magazine
221249-B21	LVD Extender kit (required for SCSI cable length exceeding 10 meters between library and HBA)

Modular Data Router	
163083-B21	MDR (1 FC x 2 LVD SCSI)
218241-B21	MDR (2 FC x 4 LVD SCSI)

compaq.com/products/storageworks/adapters.html

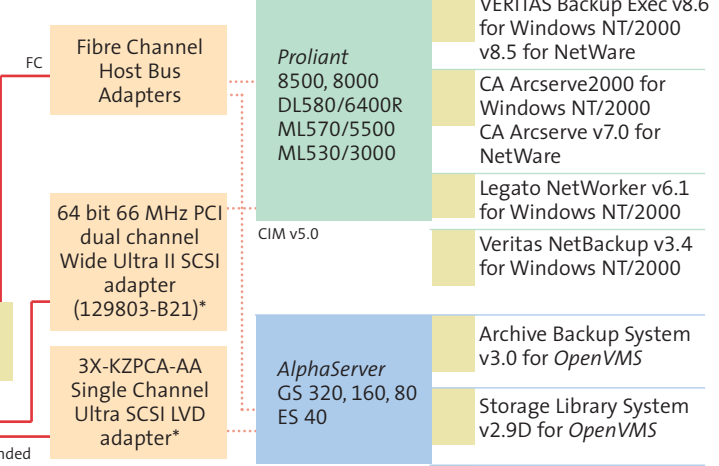

\* Note: maximum two drives per SCSI Channel recommended

### Cable Options

SCSI Cable, VHDCI/Wide, 6 ft	341176-B21
SCSI Cable, VHDCI/Wide, 12 ft	341177-B21
SCSI Cable, VHDCI/Wide, 10 m	201160-B21
SCSI Cable, VHDCI/Wide, 20 m	201160-B23
Wide Differential SCSI cable, 10 m	328215-002
Wide Differential SCSI cable, 20 m	328215-004

check the cable-adapter matrix for tape libraries on <ftp://ftp.compaq.com/pub/products/storageworks/tape-and-optical-storage/adapter-cable-matrix.pdf>

### Power Cord

ESL9326D C-KIT, SE Asia/India	146210-AR1
ESL9326D C-KIT, Central Europe	146210-021
ESL9326D C-KIT, Aus/China/NZL	146210-011
ESL9326D C-KIT, Switzerland	146210-111
ESL9326D C-KIT, UK/Hong Kong	146210-031
ESL9326D C-KIT, Italy	146210-061
ESL9326D C-KIT, Denmark	146210-081
ESL9326D C-KIT, Japan	146210-291

US/Canada/Mexico power cord included

## Compaq StorageWorks MSL5026SL Library Configuration Guide

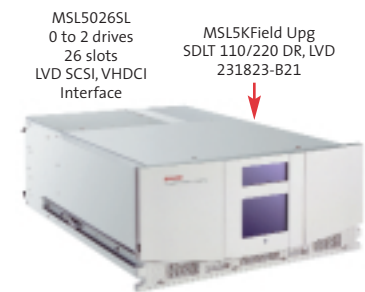

Upto 7 libraries can be connected together

MSL5026SL Library	
231822-B21	MSL5026SL, 1 SDLT 110/220, LVD, TT
231822-B22	MSL5026SL, 2 SDLT 110/220, LVD, TT
231892-B21	MSL5026SL, 1 SDLT 110/220, LVD, RM
231892-B22	MSL5026SL, 2 SDLT 110/220, LVD, RM

Modular Data Router	
163083-B21	MDR (1 FC x 2 LVD SCSI)
218241-B21	MDR (2 FC x 4 LVD SCSI)

compaq.com/products/storageworks/adapters.html

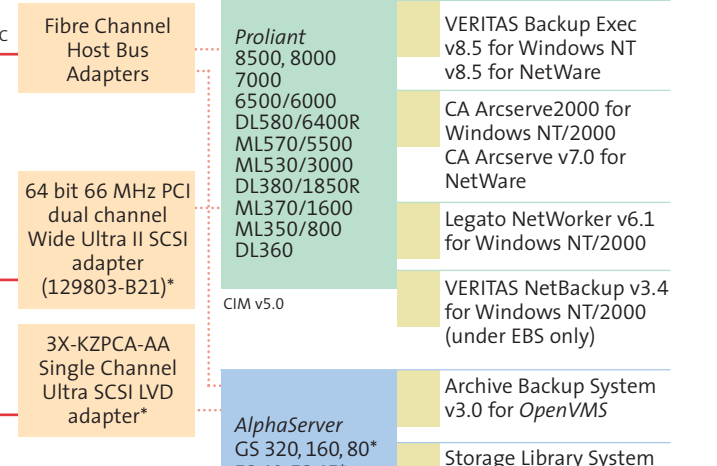

\* Note: maximum two drives per SCSI Channel recommended

### Cable Options

SCSI Cable, VHDCI/VHDCI, 6 ft	341174-B21
SCSI Cable, VHDCI/VHDCI, 12 ft	341175-B21
SCSI Cable, VHDCI/Wide, 6 ft	341176-B21
SCSI Cable, VHDCI/Wide, 12 ft	341177-B21
SCSI Cable, VHDCI/Wide, 10 m	201160-B21
SCSI Cable, VHDCI/Wide, 20 m	201160-B23

check the cable-adapter matrix for tape libraries on <ftp://ftp.compaq.com/pub/products/storageworks/tape-and-optical-storage/adapter-cable-matrix.pdf>

### Power Cord

Australia/China/New Zealand	227098-011
South East Asia/India	157220-AR1
Central Europe	157215-021
United Kingdom/Hong Kong	157216-031
Switzerland	157219-111
Italy	157217-061
Denmark	157218-081
Japan	129867-006

MRU v1.4  
\*supported in future

## Compaq StorageWorks ESL9326DX Library Configuration Guide

ESL9326DX  
0 to 16 drives  
326 slots

ESL9326DX Enterprise Library	
146205-B21	0 drives/326 slots
161265-B23	6 40/80 drives/326 slots
161265-B24	8 40/80 drives/326 slots
161265-B25	10 40/80 drives/326 slots
161265-B26	12 40/80 drives/326 slots
161265-B28	16 40/80 drives/326 slots

Modular Data Router	
163082-B21	MDR (1 FC x 2 HVD SCSI)
218240-B21	MDR (2 FC x 4 HVD SCSI)

compaq.com/products/storageworks/adapters.html

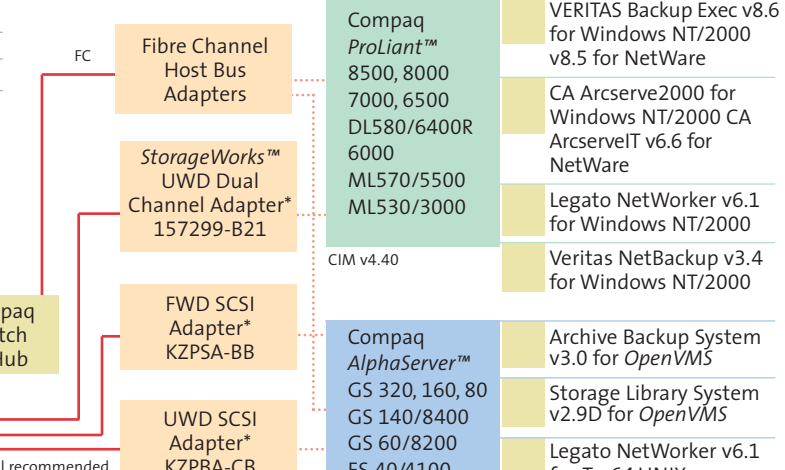

\* Note: maximum two drives per SCSI Channel recommended

### Cable Options

SCSI Cable, VHDCI/Wide, 6 ft	341176-B21
SCSI Cable, VHDCI/Wide, 12 ft	341177-B21
SCSI Cable, VHDCI/Wide, 10 m	201160-B21
SCSI Cable, VHDCI/Wide, 20 m	201160-B23
Wide Differential SCSI cable, 10 m	328215-002
Wide Differential SCSI cable, 20 m	328215-004

Check the cable-adapter matrix for tape libraries on <ftp://ftp.compaq.com/pub/products/storageworks/tape-and-optical-storage/adapter-cable-matrix.pdf>

### Power Cord

ESL9326D C-KIT, SE Asia/India	146210-AR1
ESL9326D C-KIT, Central Europe	146210-021
ESL9326D C-KIT, Aus/China/NZL	146210-011
ESL9326D C-KIT, Switzerland	146210-111
ESL9326D C-KIT, UK/Hong Kong	146210-031
ESL9326D C-KIT, Italy	146210-061
ESL9326D C-KIT, Denmark	146210-081
ESL9326D C-KIT, Japan	146210-291

US/Canada/Mexico power cord included

## Compaq StorageWorks ESL9198DLX Library Configuration Guide

ESL9198DLX  
0 to 8 drives  
198 slots

ESL9198DLX Enterprise Library	
194993-B21	0 Drive/198 slots
194993-B24	4 40/80 DLT Drives/198 slots
194993-B28	8 40/80 DLT Drives/198 slots
221249-B21	LVD Extender kit (required for SCSI cable length exceeding 10 meters between library and HBA)

Modular Data Router	
163083-B21	MDR (1 FC x 2 LVD SCSI)
218241-B21	MDR (2 FC x 4 LVD SCSI)

compaq.com/products/storageworks/adapters.html

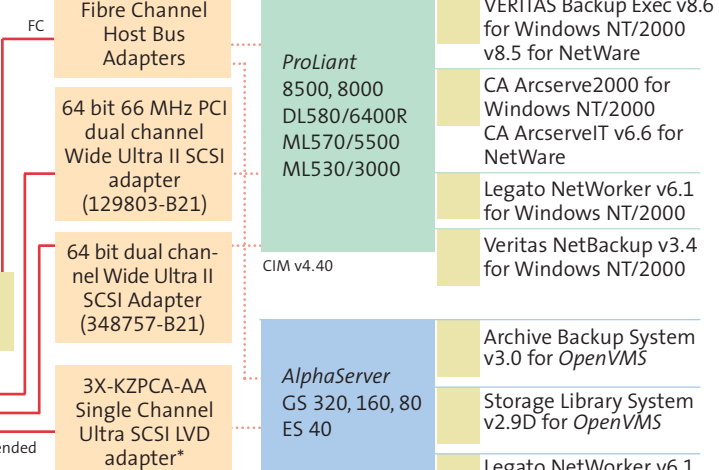

\* Note: maximum two drives per SCSI Channel recommended

### Cable Options

SCSI Cable, VHDCI/Wide, 6 ft	341176-B21
SCSI Cable, VHDCI/Wide, 12 ft	341177-B21
SCSI Cable, VHDCI/Wide, 10 m	201160-B21
SCSI Cable, VHDCI/Wide, 20 m	201160-B23
Wide Differential SCSI cable, 10 m	328215-002
Wide Differential SCSI cable, 20 m	328215-004

check the cable-adapter matrix for tape libraries on <ftp://ftp.compaq.com/pub/products/storageworks/tape-and-optical-storage/adapter-cable-matrix.pdf>

### Power Cord

ESL9326D C-KIT, SE Asia/India	146210-AR1
ESL9326D C-KIT, Central Europe	146210-021
ESL9326D C-KIT, Aus/China/NZL	146210-011
ESL9326D C-KIT, Switzerland	146210-111
ESL9326D C-KIT, UK/Hong Kong	146210-031
ESL9326D C-KIT, Italy	146210-061
ESL9326D C-KIT, Denmark	146210-081
ESL9326D C-KIT, Japan	146210-291

US/Canada/Mexico power cord included

## Compaq StorageWorks MSL5026SL Multi-unit Configurations



231892-B21 MSL5026SL, 1 SDLT 110/220 DR, LVD, RM

231892-B22 MSL5026SL, 2 SDLT 110/220 DR, LVD, RM

Table Top to Rack Mount Conversion Kits	
231894-B22	MSL5026 TT-RK Kit, Compaq Rack



Multi-Unit Configurations upto 7 units can be scaled together

MSL5026 Pass-Thru Mechanism 231824-B21, Required to connect first two units

MSL5026, Pass Through Extender 231824-B22, required one for each unit connected to the stack, for third and more units

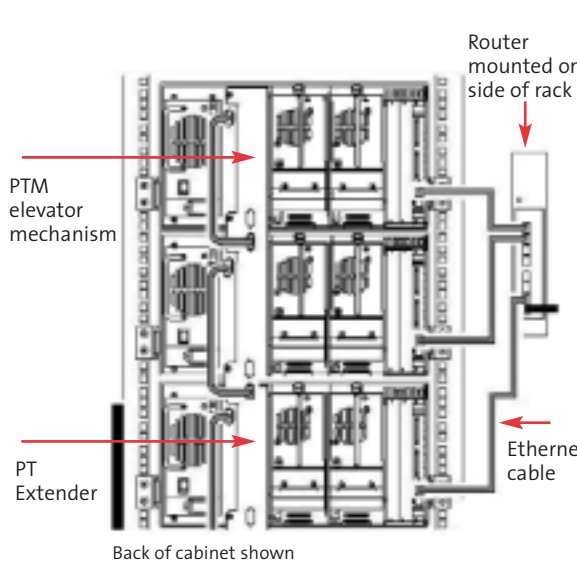

Back of cabinet shown

MSL5026 Pass-Thru Mechanism 231824-B21, includes elevator mechanism and router

Required to connect first two units



# Compaq StorageWorks TL891DLX MiniLibrary Config Guide

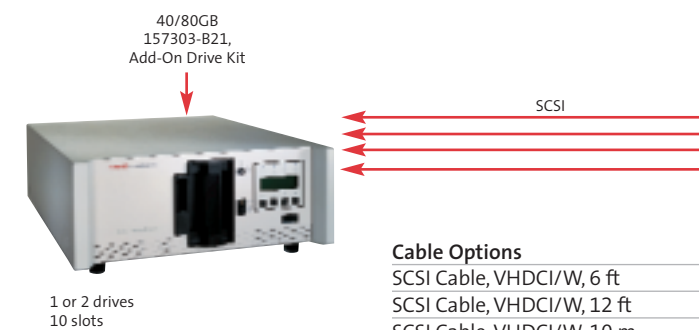

TL891DLX MiniLibrary (Base Unit Only)		Modular Data Router	
157300-B21	1 drive/10 slots, table top, LVD	163083-B21	MDR (1 FC x 2 LVD SCSI)
157300-B22	2 drives/10 slots, table top, LVD	218241-B21	MDR (2 FC x 4 LVD SCSI)
157305-B21	1 drive/10 slots, rack mount, LVD		
157305-B22	2 drives/10 slots, rack mount, LVD		
157301-B21	MiniLibrary Expansion Unit, LVD		
Accessories			
120881-B21	10 Slot Magazine		

Cable Options	
SCSI Cable, VHDCI/W, 6 ft	341176-B21
SCSI Cable, VHDCI/W, 12 ft	341177-B21
SCSI Cable, VHDCI/W, 10 m	201160-B21
Wide Differential SCSI cable, 10 m	328215-002

check the cable-adapter matrix for tape libraries on <ftp://ftp.compaq.com/pub/products/storageworks/tape-and-optical-storage/adapter-cable-matrix.pdf>

Power Cord	
Australia/China/New Zealand	227098-011
South East Asia/India	157220-AR1
Central Europe	157215-021
United Kingdom/Hong Kong	157216-031
Switzerland	157219-111
Italy	157217-061
Denmark	157218-081
Japan	120884-291

# Compaq StorageWorks TL895 Configuration Guide

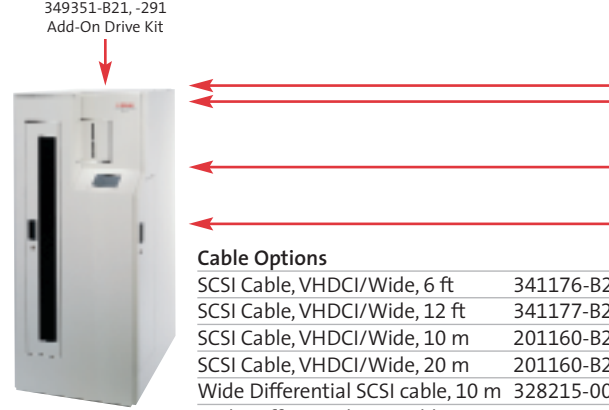

TL895 Library		Modular Data Router	
349350-B22	2 drives/96 slots	163082-B21	MDR (1 FC x 2 HVD SCSI)
349350-B23	3 drives/96 slots	218240-B21	MDR (2 FC x 4 HVD SCSI)
349350-B24	4 drives/96 slots		
349350-B25	5 drives/96 slots		
349350-B26	6 drives/96 slots		
349350-B27	7 drives/96 slots		

Cable Options	
SCSI Cable, VHDCI/Wide, 6 ft	341176-B21
SCSI Cable, VHDCI/Wide, 12 ft	341177-B21
SCSI Cable, VHDCI/Wide, 10 m	201160-B21
SCSI Cable, VHDCI/Wide, 20 m	201160-B23
Wide Differential SCSI cable, 10 m	328215-002
Wide Differential SCSI cable, 20 m	328215-004

check the cable-adapter matrix for tape libraries on <ftp://ftp.compaq.com/pub/products/storageworks/tape-and-optical-storage/adapter-cable-matrix.pdf>

Localization Kit (Power Cord)	
Australia/China/New Zealand	227098-011
South East Asia/India	157220-AR1
Central Europe	157215-021
United Kingdom/Hong Kong	157216-031
Switzerland	157219-111
Italy	157217-061
Denmark	157218-081
Japan	120884-291

# Compaq StorageWorks

# Tape Automation Configuration Guide

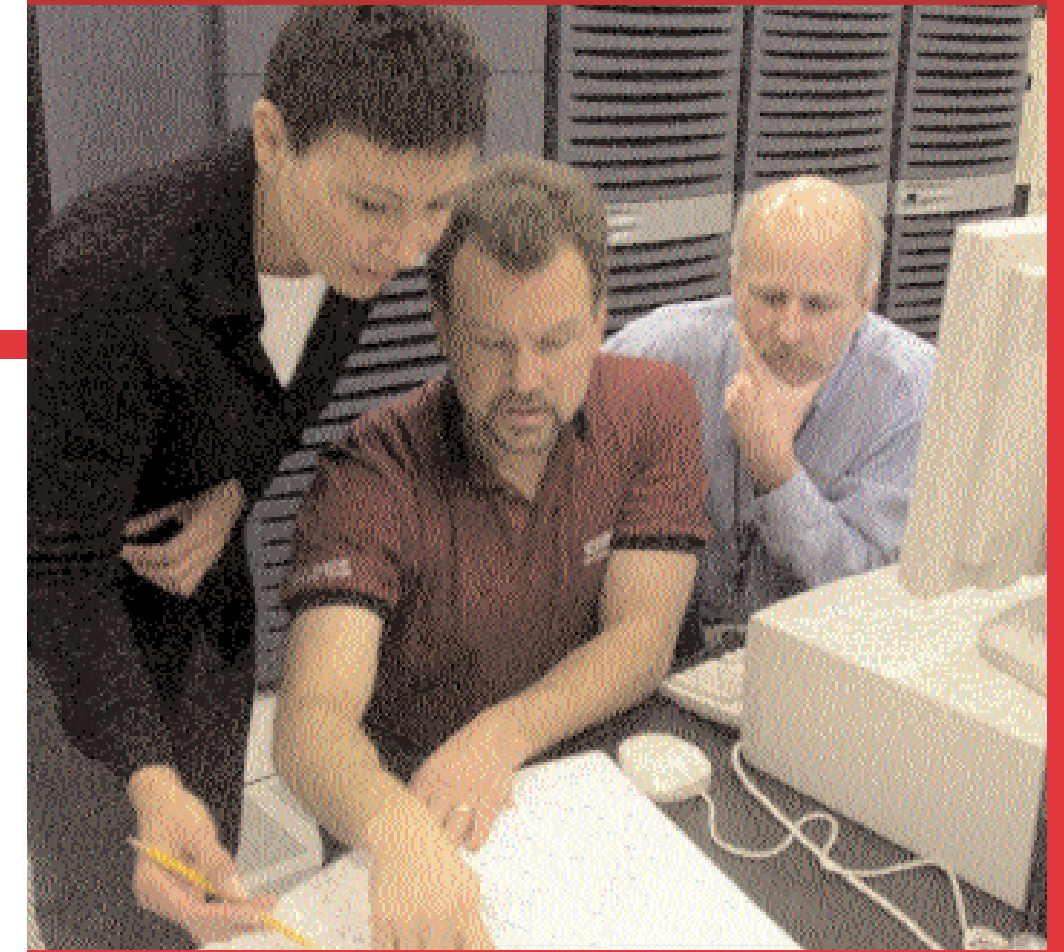

# Compaq StorageWorks TL891DLX Configuration Guide, Multi-Configurations



Multi-Unit Configurations	
157301-B21	MiniLibrary Expansion Unit, LVD no drives, 16 slots (Required as top unit in multi-unit configuration, provides for global robotic control)
157305-B2x	TL891DLX DLT Library, Rack Mount
128670-B21	MiniLibrary Data Unit Support up to 6 modules > TL891DLX MiniLibrary units or > MiniLibrary Data units

  

MiniLibrary Pass-Thru Mechanism	
120880-B21	Provided with each MiniLibrary Expansion Unit (supports two modules)

MiniLibrary Pass-Thru Extension Kit	
120880-B21	Required for additional modules (beyond first two)

# Compaq StorageWorks SSL2020 Library Configuration Guide

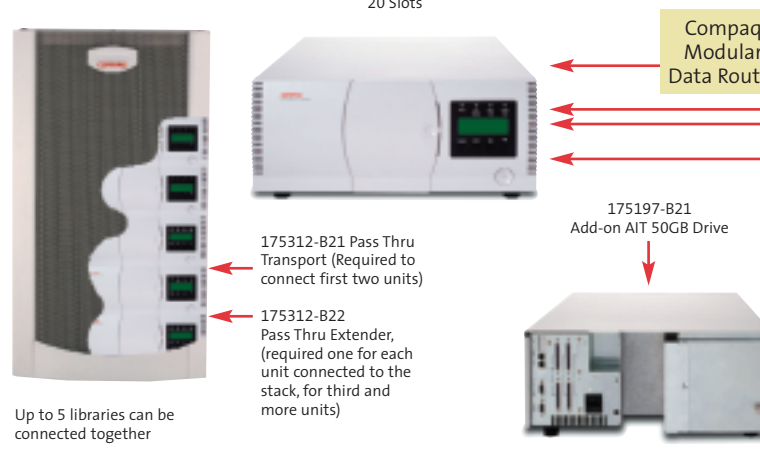

SSL2020 AIT Tape Library		Modular Data Router	
175195-B21	1 drive/20 slots TT	163083-B21	MDR (1 FC x 2 LVD SCSI)
175195-B22	2 drives/20 slots TT	218241-B21	MDR (2 FC x 4 LVD SCSI)
175196-B21	1 drive/20 slots RM		
175196-B22	2 drives/20 slots RM		

Cable Options	
Wide Differential SCSI cable, 5 m	328215-001
Wide Differential SCSI cable, 10 m	328215-002
Wide Differential SCSI cable, 15 m	328215-003
Wide Differential SCSI cable, 20 m	328215-004
SCSI Cable, VHDCI/W, 6 ft	341176-B21
SCSI Cable, VHDCI/W, 12 ft	341177-B21

compaq.com

Compaq, the Compaq logo, ProLiant, StorageWorks and AlphaServer are registered in U.S. Patent and Trademark Office. SANworks is a trademark of Compaq Information Technologies Group, L.P. Other product or company names mentioned herein may be trademarks or registered trademarks of their respective companies. Compaq believes the information in this publication is accurate as of its publication date; such information is subject to change without notice. Compaq is not responsible for any inadvertent errors. Printed in the U.S.A. 15HS-0901A-WWEN © 2001 Compaq Computer Corporation

**COMPAQ**  
Inspiration Technology

**COMPAQ**  
Inspiration Technology