

June 2003 (revised)

Prepared by:
Network Storage Solutions
Hewlett Packard Company

Contents

Benefits of the MSA1000 Enhancements	1
Prerequisites.....	3
Environmental Monitoring Unit (EMU) issue:.....	3
Procedures for Upgrading MSA1000 and Components	5
Overview of Steps.....	5
Microsoft Clusters.....	7
HBA Install and Driver Update / Install.....	8
Firmware Upgrades to MSA1000 Controller, EMU and MSA Fabric Switch6.....	11
Procedures for All Operating System Environments	11
Upgrading Array Controller Utility (ACU)	30
Upgrading to Secure Path 4.0 ..	30
Externally (SAN) Booted Configurations.....	31
Summary	31

Upgrading the MSA1000 for Enhanced Features

***Abstract:** This white paper outlines step-by-step procedures to upgrade an MSA1000 and its components to enable enhanced features*

Benefits of the MSA1000 Enhancements

The newest enhancements to the StorageWorks Modular SAN Array 1000 add significant features and functionalities to this entry level and mid-range storage solution. “Multi-clustering” capability will now be supported, adding the ability to attach numerous clusters and individual servers to a single MSA1000. Support for Linux and NetWare operating systems is now included along with the original support for Windows NT and Windows 2000. An optional new three-port embedded “mini-hub” is available to facilitate easy and inexpensive two-node clustering. This new hardware is especially desirable to the end-user needing smaller, easy-to-implement solutions. Further, new hot-plug features like adding additional storage shelves are also enabled.

These features add significantly to the attractiveness of the product for the mid-range and larger customers. These features are enabled by performing firmware upgrades on the MSA1000 controller and the Environmental Monitoring Unit (EMU). This white paper will explain the necessary steps to perform the firmware upgrades to allow this support.

Notice

Document Number © 2003 Hewlett Packard Company

Hewlett Packard, HP, Compaq, StorageWorks, Smart Array, SupportPaq, and the HP and Compaq logo are trademarks of Hewlett Packard Company.

Microsoft, Windows, and Windows NT are trademarks and/or registered trademarks of Microsoft Corporation.

Other product names mentioned herein may be trademarks of their respective companies.

Hewlett Packard shall not be liable for technical or editorial errors or omissions contained herein. The information in this document is provided “as is” without warranty of any kind and is subject to change without notice. The warranties for Hewlett Packard products are set forth in the express limited warranty statements accompanying such products. Nothing herein should be construed as constituting an additional warranty.

Prerequisites

Environmental Monitoring Unit (EMU) issue:

An issue was uncovered with a certain manufacturers EEPROM (electrically erasable programmable read-only memory) chip in combination with EMU firmware version 1.78 or lower. If the EEPROM chip is from this manufacturer AND the firmware version is 1.78 or lower, the chip firmware cannot be flashed. Steps to determine firmware version and chip vendor are as follows:

Determining EMU Firmware version

To determine if this is a problem on your hardware, first the EMU firmware revision must be gathered. There are several methods to determine the current firmware revision of your EMU. Perhaps the easiest method is to use the keypad on the front of the MSA1000 controller to scroll through the messages on the LED. The EMU firmware is displayed with a message like this on the LED:

```
413  STORAGE BOX #1
      EMU VERSION 1.78
```

In this case, the version of the EMU firmware is 1.78. Now the brand of the EEPROM must be determined. **If the firmware version were greater than 1.78, the next step would NOT have to be carried out.**

Determining EMU (EEPROM) Manufacturer

To determine the manufacturer of the EMU in the MSA1000, the MSA1000 will have to be powered off (make sure there is no I/O running from a server to the MSA1000 before powering it off). At the back of the MSA1000 chassis, remove the SCSI cables (if attached) on the SCSI Interconnect board (located on the left of the MSA1000 unit) – see drawing below:

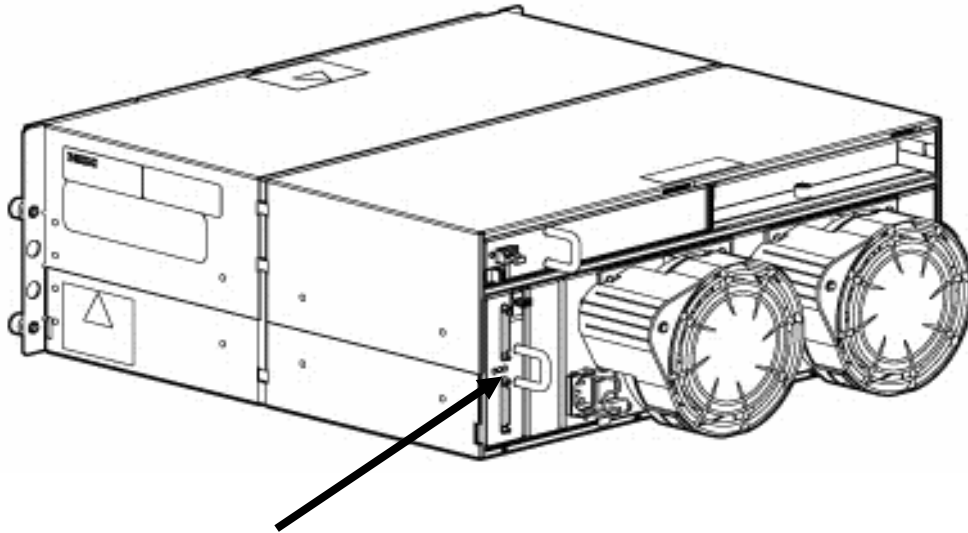

Once the cables have been disconnected, remove this card from the back of the MSA1000 chassis by simultaneously pushing down on the quick release latch mechanism and pulling the card out. Once the card is out, set it down on a flat surface, metal part of the card face down. If the SCSI ports on the card are facing to the left, the EMU EEPROM is located towards the bottom right section of the printed circuit board. It is the only chip on the board that is located in a solder-less connector.

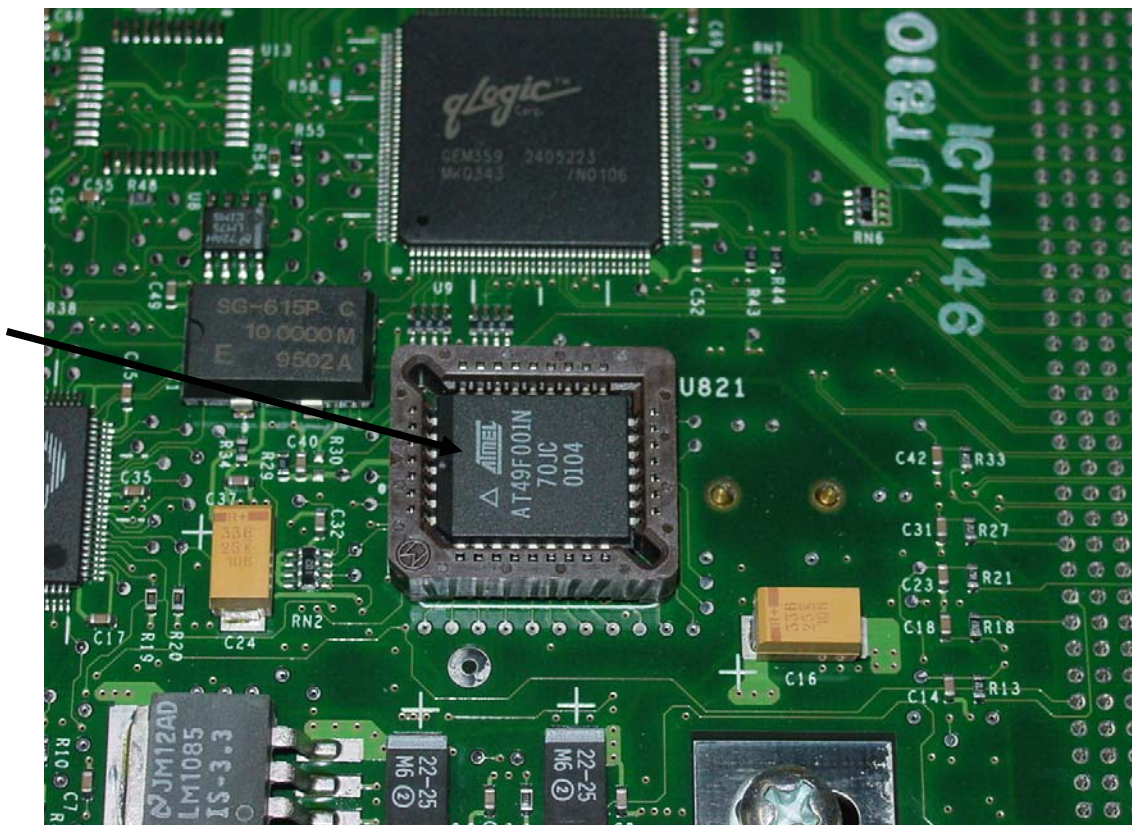

Once the chip is located, look closely at the wording on the chip. If the chip reads **AMD**, this chip is flashable, and the upgrade procedures can continue. **If the chip reads ATMEL, this chip is NOT flashable. Please call HP Customer Services to have this board replaced.**

Procedures for Upgrading MSA1000 and Components

Overview of Steps

These steps are listed in much greater detail in the Operating System specific pages. This list is just to give an overview of the steps to be performed and the components necessary to accomplish the upgrade.

As a best practices precaution, perform a full backup (and verify the backup) of all data on the MSA1000 if it is in a production environment.

After the backup has been performed and verified, the following steps, which are listed in much greater detail later in this document, need to be carried out for the upgrade:

1. Stop and Disable the Cluster services (Microsoft Cluster environments only)
2. Stop any database services that are running (there is a known issue between SQL Server db services and the msa1000 firmware flash utility that prevents the flash utility from performing its function).
3. Upgrade the HBA driver
4. Upgrade the firmware on the MSA1000 controller, the Environmental Monitoring Unit (EMU) and the Fabric Switch.
5. Upgrade the Array Configuration Utility
6. Install Secure Path version 4.0 to support new MSA1000 firmware (if applicable)
7. For external (SAN) boot only, using HBA Boot BIOS utility, re-point to the boot LUN.

To make the upgrades easier, it is suggested that you have the following in hand before beginning the upgrade procedure.

- The **HP Modular SAN Array 1000 FW Upgrade CD**, which can be obtained from:

<http://www.compaq.com/products/storageworks/msa1000/index.html>

(then select the “software, firmware & drivers” link)

This ISO image will allow you to create a bootable CD from which the firmware upgrade can take place. Download this image, and use your favorite CD ROM burning software to create the CD – this is referred to as an OFFLINE upgrade.

MSA1000 Support Software CD. This CD not only has a wealth of documentation, but it also has the latest revisions of the supported HBA drivers, Array Configuration Utility (ACU), and a utility to install them. This CD is the source of the correct firmware and drivers for msa1000 support – no other source for firmware or drivers should be used.

- The **HP Modular SAN Array 1000 Support Software CD**, which can be obtained from:

<http://www.compaq.com/products/storageworks/msa1000/index.html>

(then select the “software, firmware & drivers” link)

- Secure Path 4.0 upgrade (if applicable), which can be obtained from :
<http://www.compaq.com/products/storageworks/msa1000/index.html>
(then select the “software, firmware & drivers” link)

Microsoft Clusters

If you are performing these upgrades in a Microsoft clustered environment, Microsoft cluster services must first be “Stopped” and “Disabled”.

For Windows 2000 Clusters:

On the Standby Node, stop the Cluster services, and then Disable the Startup Type. Proceed to the Active Node and do the same.

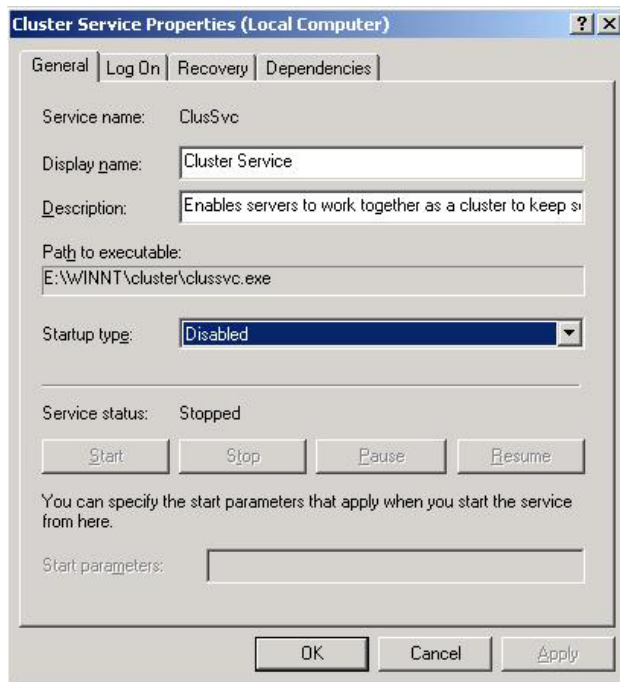

For NT 4.0 Clusters:

On the Standby Node, stop the Cluster services, and then Disable the Startup Type. Proceed to the Active Node and do the same.



HBA Install and Driver Update / Install

To fully support the enhancements to the MSA1000, the HBA drivers need to be updated.

Windows NT / Win2K Driver Update / Install

There is an updated driver for Windows systems that must be installed, which is contained on the MSA1000 Support Software CD. Insert the CD in the server's CD ROM drive, and that will bring up a menu. The "**Install Windows HBA Drivers**" is the second option on the main menu of the MSA1000 Support Software CD. Click on "**Install Windows HBA Drivers**" to install or upgrade the HBA drivers. After clicking on that option, a message will be presented about "Extracting Drivers", followed by a screen stating "The software is installed but is not up to date". Click on the "**Install**" to complete the driver upgrade or installation (NOTE: If this server did not have previously installed drivers, this message would not have been presented).

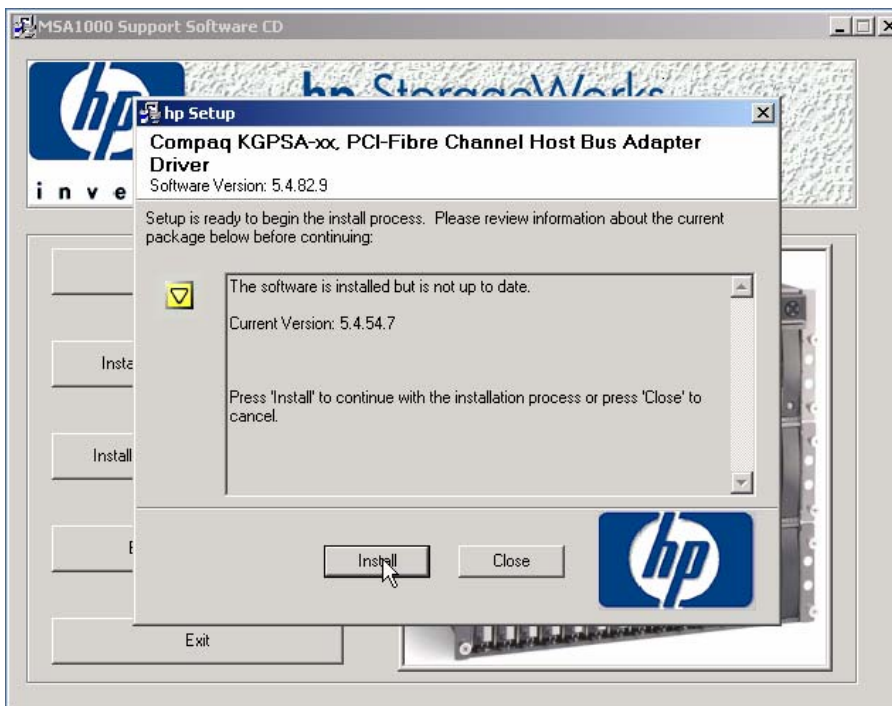

After clicking the "Install" button, the software will be installed, and shortly a message will appear:

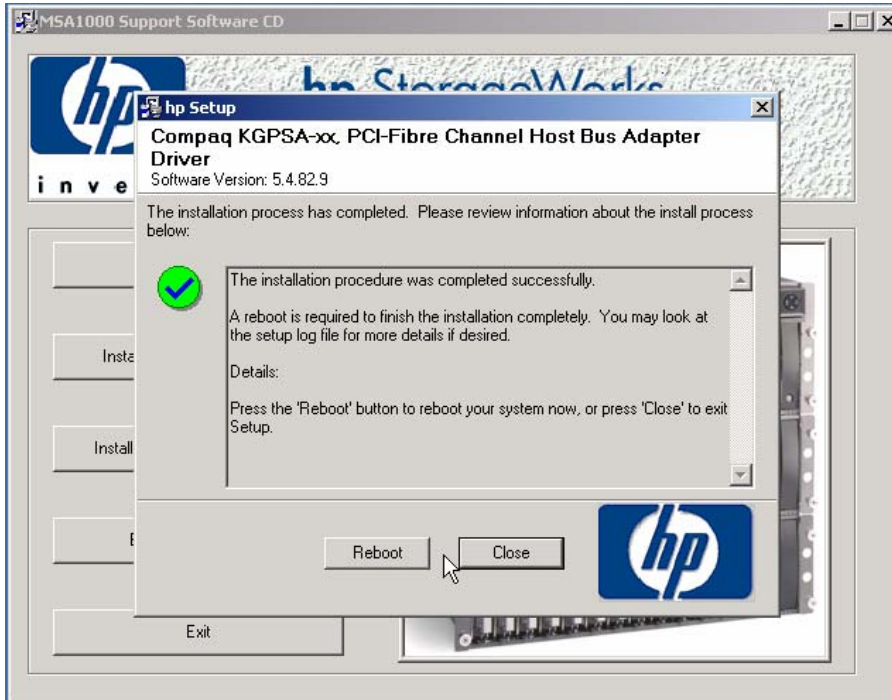

At this point, the server can be rebooted (remember to remove the CD ROM from the CD ROM drive).

In a Microsoft Cluster environment, perform the HBA driver upgrade on the Standby Node first. After a successful upgrade of the Standby Node NBA driver, shut down that server. Then perform the same HBA driver update steps on the Active Node.

NetWare HBA Driver Installation

1. Insert the MSA1000 Support Software CD version 6.11 into the CD-ROM drive of the server.
2. From the system console, mount the CD-ROM drive by entering:
CDROM
3. From the system console, enter the following command:
NWCONFIG
4. The Configuration Options menu is displayed.
5. From the Options menu, select Driver Options.
6. Select "Select an additional driver".
7. Press <Insert> to install an unlisted driver.
8. Press <F3> to specify the path to the HAM driver. The path to specify is
HPSSCD611:\NetWare\drivers
(HPSSCD611 is the volume name of the MSA1000 Support Software CD for NetWare / Linux)
9. Press <Enter> to select the QLogic HAM driver and select "Yes" to copy the driver from the CD to the server directory (for both the .HAM and .DDI file)
10. Specify the path where you want the drivers to be copied to (default is C:\NWSERVER).

11. Choose “Select/Modify driver parameters”, and press Enter. Add the slot number (this corresponds to the numbered PCI slot that the HBA was installed in).
12. Press Escape, select “Save parameters and load driver”
13. When asked, “Do you want to select an additional Disk driver?”, select “No” and press Enter.
14. Exit from the NWCONFIG utility, dismount the CD ROM, and down the NetWare server.

This completes the HBA Driver install for NetWare.

Linux HBA Driver Installation

Because this process involves updating your configuration for the MSA1000, HP recommends performing this task during inactive periods.

After the HBA driver is installed, it will automatically load on each system boot and will provide optimized support for Secure Path multi-path storage configurations, as well as single-path storage configurations.

1. Install the HBA(s) in the server, power on the server, and start up your Linux operating system.
2. From the console, log on as the root user.
3. Insert the MSA1000 Support Software CD in the CD-ROM drive of the server.
4. From the console, mount the CD-ROM drive and navigate to the `/LINUX` directory on the CD.
5. List the contents of the directory and identify the RPM file for your distribution of Linux.
6. Install the FCA2214 HBA driver on the new kernel by entering:

```
rpm -Uvh rpm filename
```

where rpm filename is the name of the rpm file for your distribution of Linux.

After a few minutes, the following messages are displayed:

```
Attempting to load qla2200 ..... FAILED
Attempting to load qla2300 ..... OK
```

7. For Red Hat Linux 7.2 Professional and Red Hat Linux Advanced Server 2.1, run the provided script to modify the SCSI blacklist.
 - a. Navigate to the `/opt/hp/storage_drivers/qla604/utils` directory.
 - b. Enter the command `scriptname edit_initrd.redhat`
 - c. Follow the on-screen instructions to complete the update.
8. Remove the MSA1000 Support Software CD from the CD drive and reboot your Linux server now or proceed with other installation procedures and reboot your server later.
9. Connect the MSA1000 to the SAN, if it is not already connected.

This completes the HBA Driver install for Linux.

Firmware Upgrades to MSA1000 Controller, EMU and MSA Fabric Switch6

Procedures for All Operating System Environments

Flashing the MSA1000 Controller Firmware – Offline Flash Utility

The first step involved in flashing the MSA1000 firmware is to power down all servers that are connected to the MSA1000. Please follow appropriate methods to bring down applications, servers, clusters, etc. Place the MSA1000 Firmware Upgrade CD in a server's CD ROM drive (that is connected to the MSA1000), and power up the server. The server will boot to the MSA1000 Firmware Upgrade CD. When the utility is fully booted, the MSA1000 utility screen will appear with the options to flash the MSA1000 firmware, the Environmental Monitoring Unit, or the Fabric Switch6 (if installed).

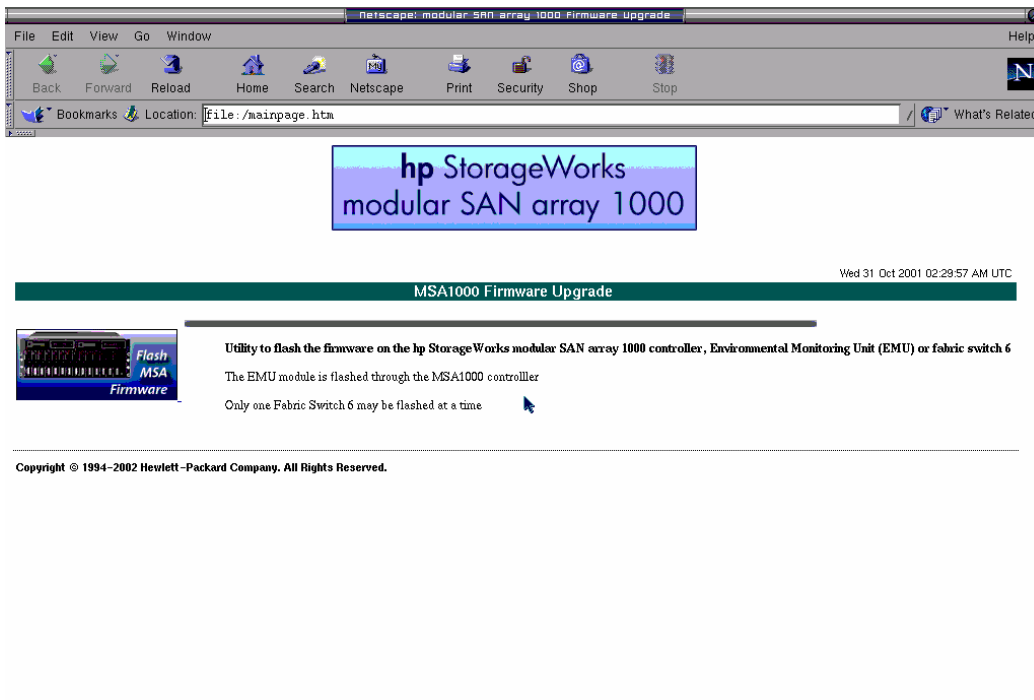

Select the Flash MSA Firmware option – The screen will look like this: Click on the **Find MSA** button. Note that the MSA Flash Utility found two MSA1000's on the SAN.

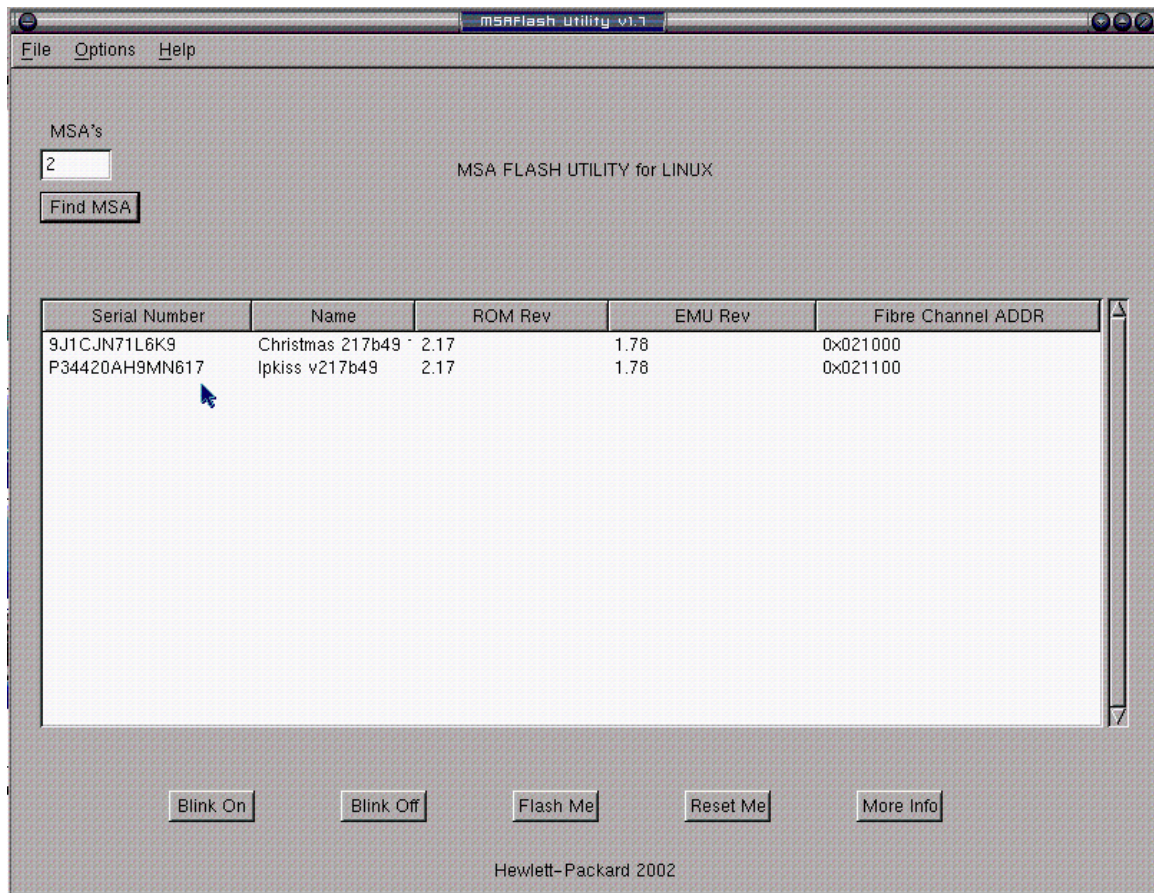

Select the controller you wish to flash the firmware of by highlighting it with a single click. Then, click on the **Flash Me** button. Your screen will appear as follows:

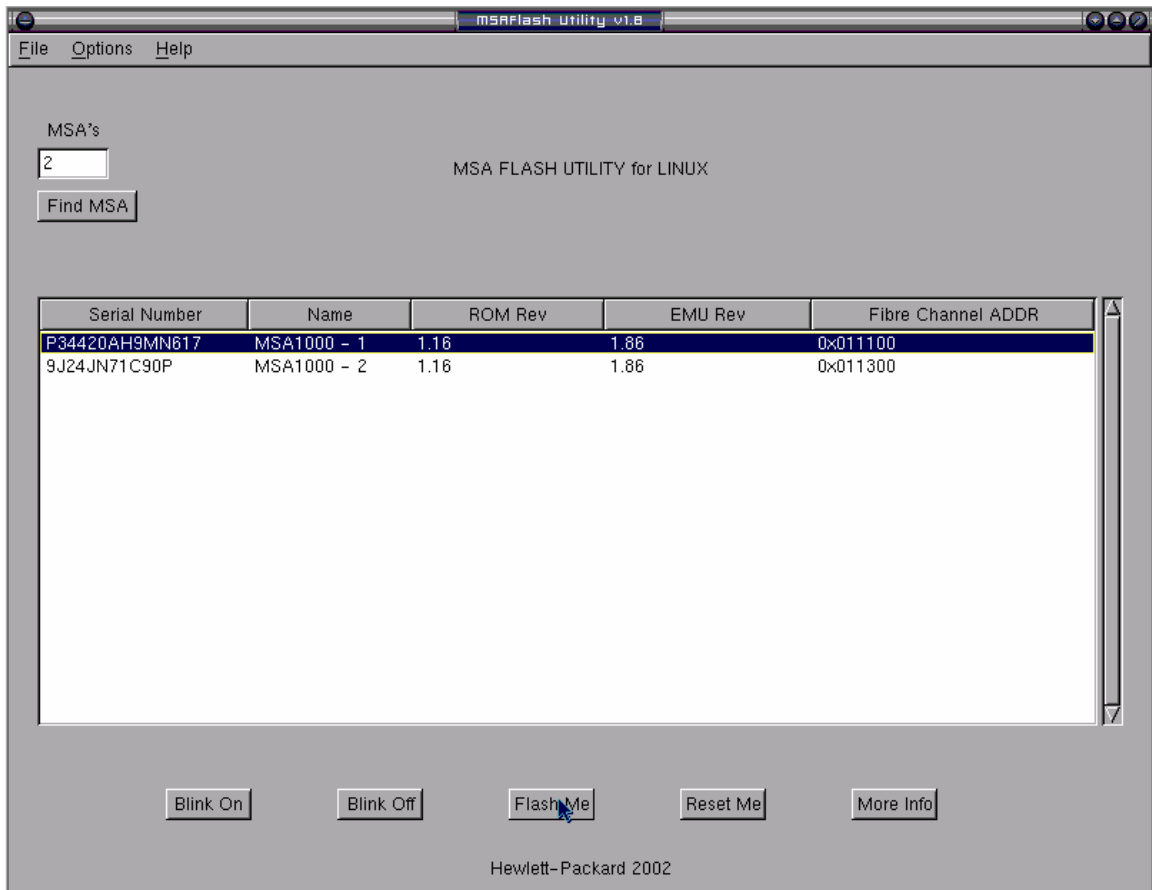

After clicking on the **Flash Me** button, a directory window will appear. From this window, select the firmware file for the MSA1000 (currently v228b80.bin), and click on the **OK** button. The MSA1000 firmware file will begin with a “v” and have a .bin extension.

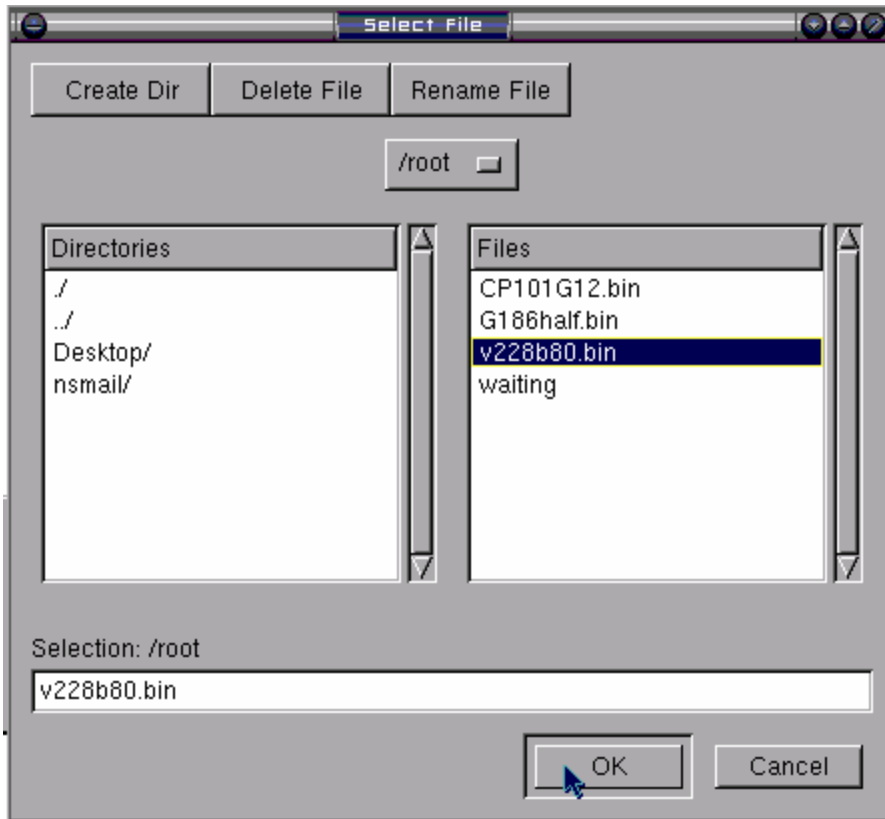

After selecting the firmware image, a note will pop up about the length of time to flash the firmware. This is just an informational message. Click on the **YES** button to continue.

A progress indicator will appear, giving status of the firmware update.

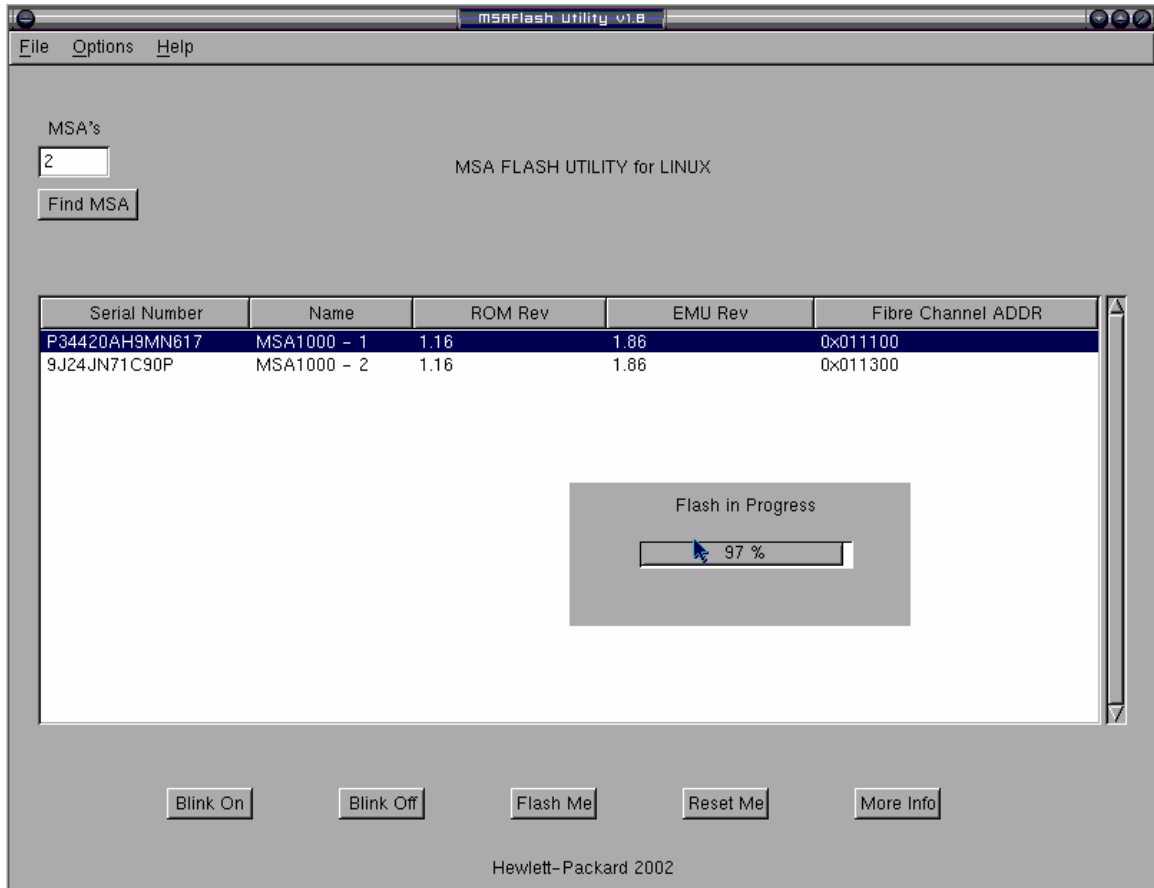

A **Flash Successful!** message will pop up. Close this message. This will take you back to the MSA1000 Firmware Flash Utility main menu

From this main menu, highlight the controller that was just flashed, and click on the **Reset Me** button (the MSA1000 controller has to be reset (rebooted) for the firmware changes to take effect. The reset of the MSA1000 controller will take 2 – 5 minutes.

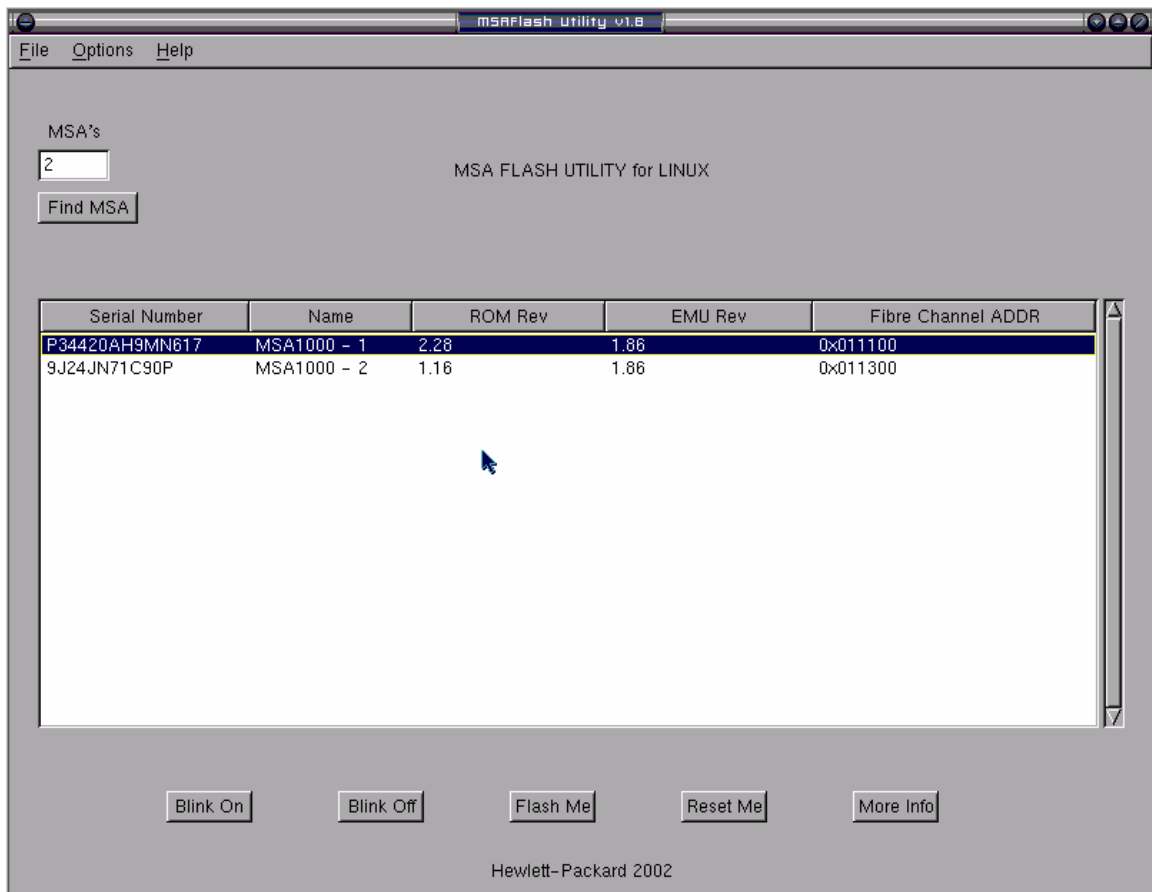

Once the MSA1000 controller has finished its reboot, clicking on the **Find MSA** button on the main menu will force a rescan, and display the MSA1000 controllers that are found. Notice that the Firmware had been updated from revision 1.16 to revision 2.28 (2.28 was the latest version as of the writing of this paper).

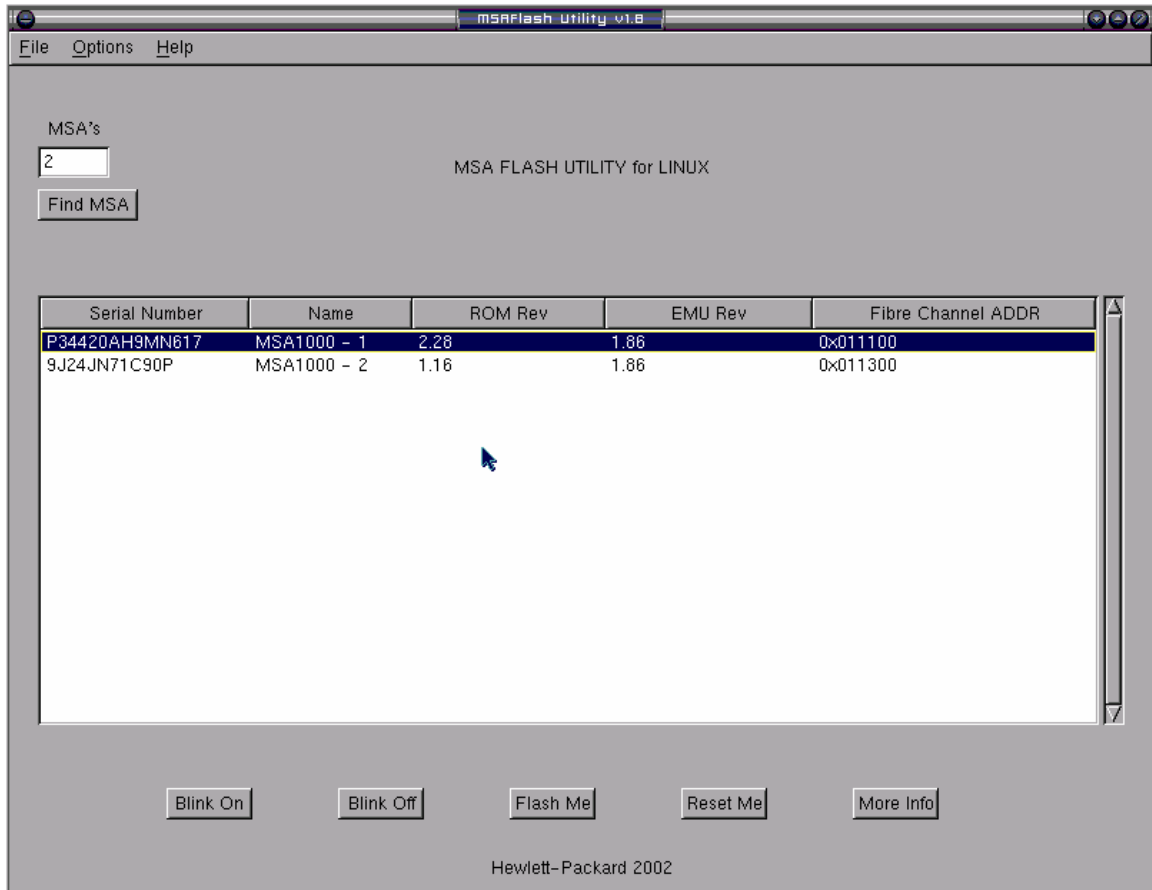

If you have other MSA1000 controllers, you can flash the firmware on those controllers now. If there are no other controllers to flash, please move on to the next section.

Flashing the Environmental Monitoring Unit (EMU) Firmware

This next procedure describes the steps for upgrading the Environmental Monitoring Unit (EMU). This EMU firmware upgrade will allow HP Storage Works controller shelves to be “hot plugged” to the MSA1000. Previously, the MSA1000 had to be reset after the storage shelves were attached for the MSA1000 to recognize them. If this is not a needed feature in your environment, the EMU firmware does not have to be upgraded.

WARNING: Please review the Prerequisites section of this paper (page 3) before continuing with these steps.

These steps are similar to flashing the MSA1000 controller firmware.

As before in the previous step, you will select the controller from the main menu of the bootable MSA1000 Firmware Upgrade CD that you want to flash.

Once the MSA1000 controller is selected, click on the **Flash Me** button. A directory window will once again appear, allowing you to select the EMU firmware update file (currently G186half.bin). Highlight this file, and then click on the **OK** button.

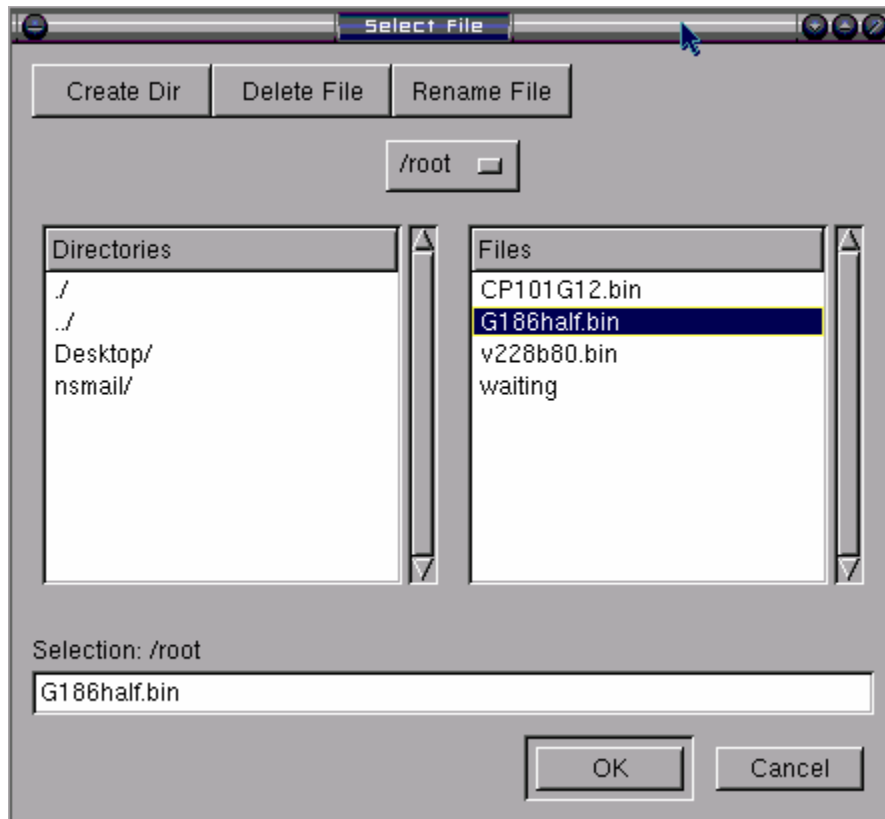

Once again, a message will pop up explaining that the firmware flash can take from 3 to 5 minutes. Click **Continue** to start the upgrade process.

Warning: Please review the Prerequisites section (page 3) of this paper. DO NOT continue with the EMU firmware upgrade if you have not verified EMU firmware level and EMU EEPROM manufacturer per the Prerequisites section. If you have verified the firmware version and the EMU EEPROM manufacturer, click on the **YES** button to continue. If this has not been verified, click on the **NO** button to cancel. Review Prerequisites section (page 3).

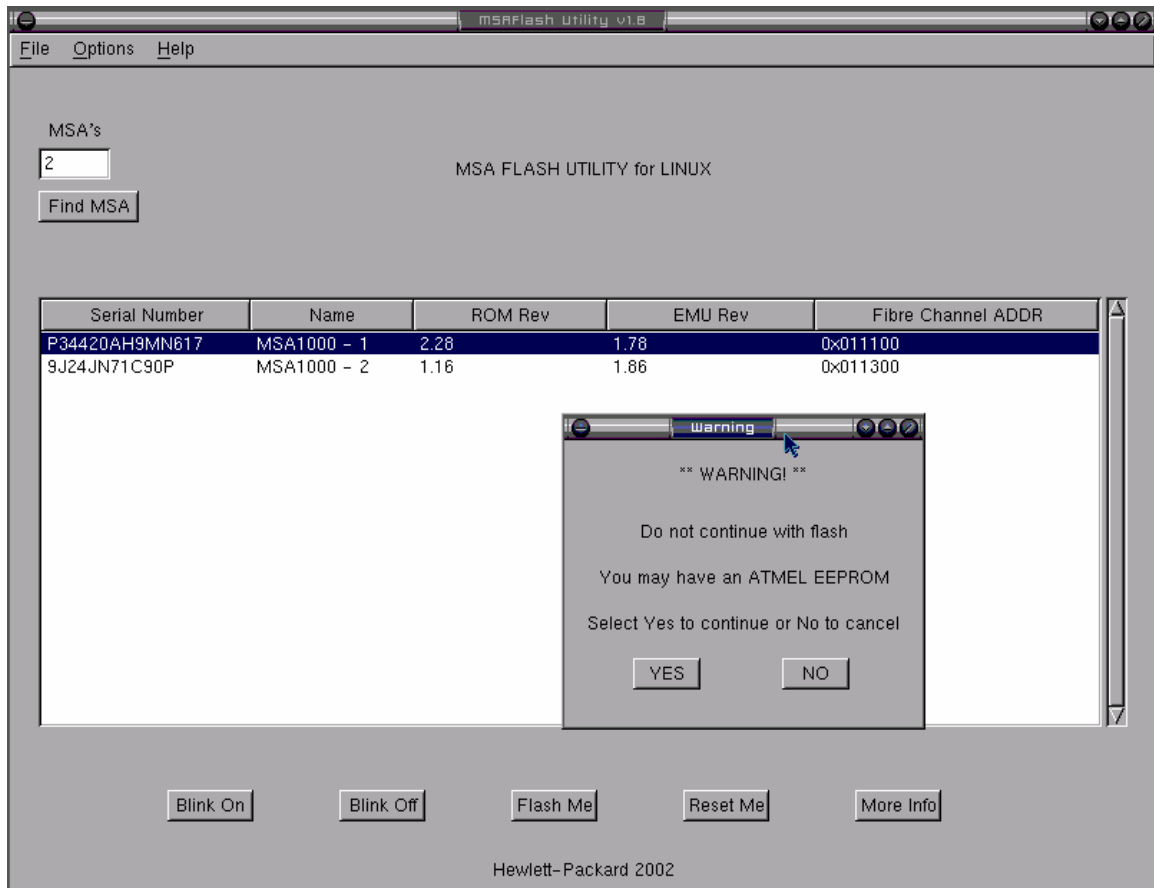

After selecting the **Yes** to continue with the EMU firmware flash, a status message will occur.

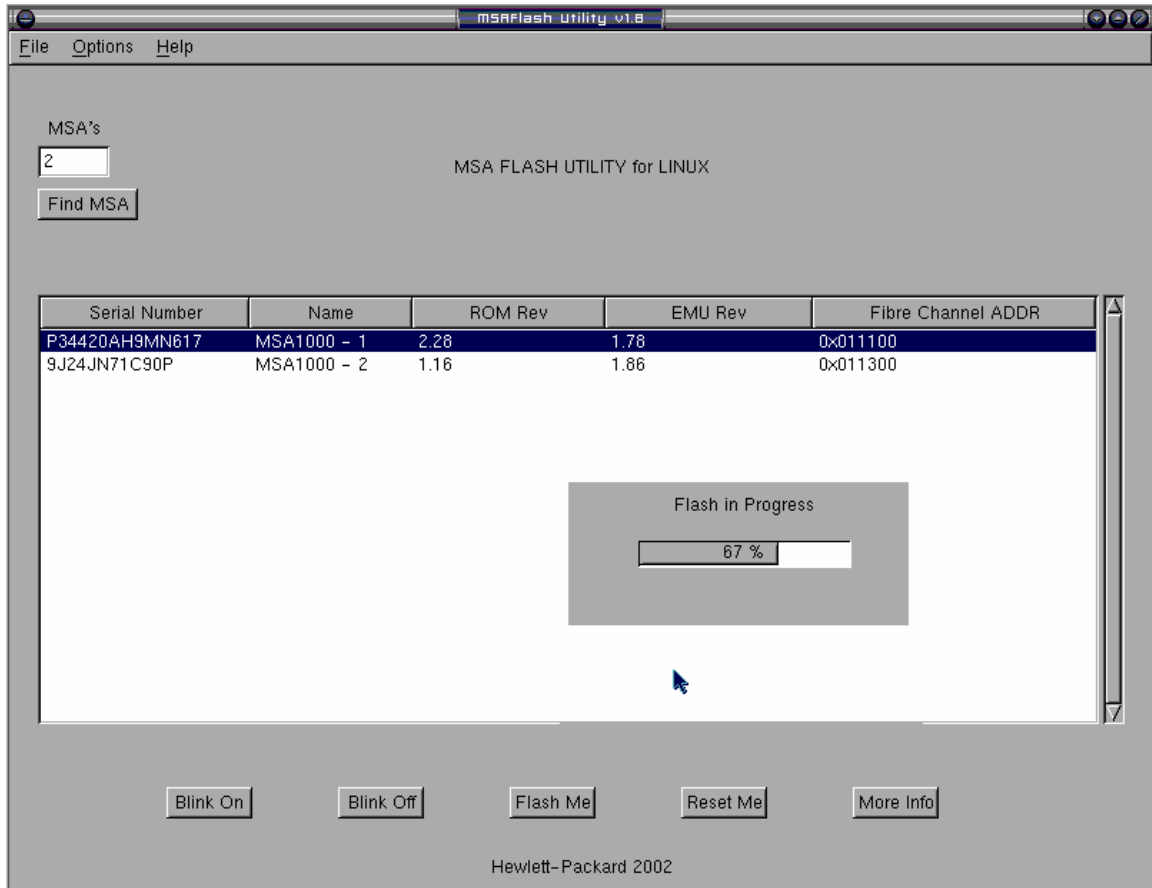

The firmware flash will take from 3 to 5 minutes to complete. A **Flash Successful !** message will appear when complete. Close this message, and from the MSA1000 Firmware Flash Utility main menu, again highlight the controller that was just flashed.

NOTE: It is possible that the MSAFlash Utility will report a failure (Flash Failure !) in the flashing of the MSA1000 Controller due to a "SCSI error" condition. However, the flash was successful, and can be verified via the MSA1000 LED console, which will read "FLASH SUCCESSFUL".

After the controller has been highlighted, click on the **Reset Me** button, as the MSA1000 controller has to be reset again for the changes to take effect.

The MSA1000 controller will take several minutes to reset. After a successful reset, click the **Find MSA** button to force a rescan of the MSA1000 controllers. After the rescan, you will notice that the EMU firmware version has been updated.

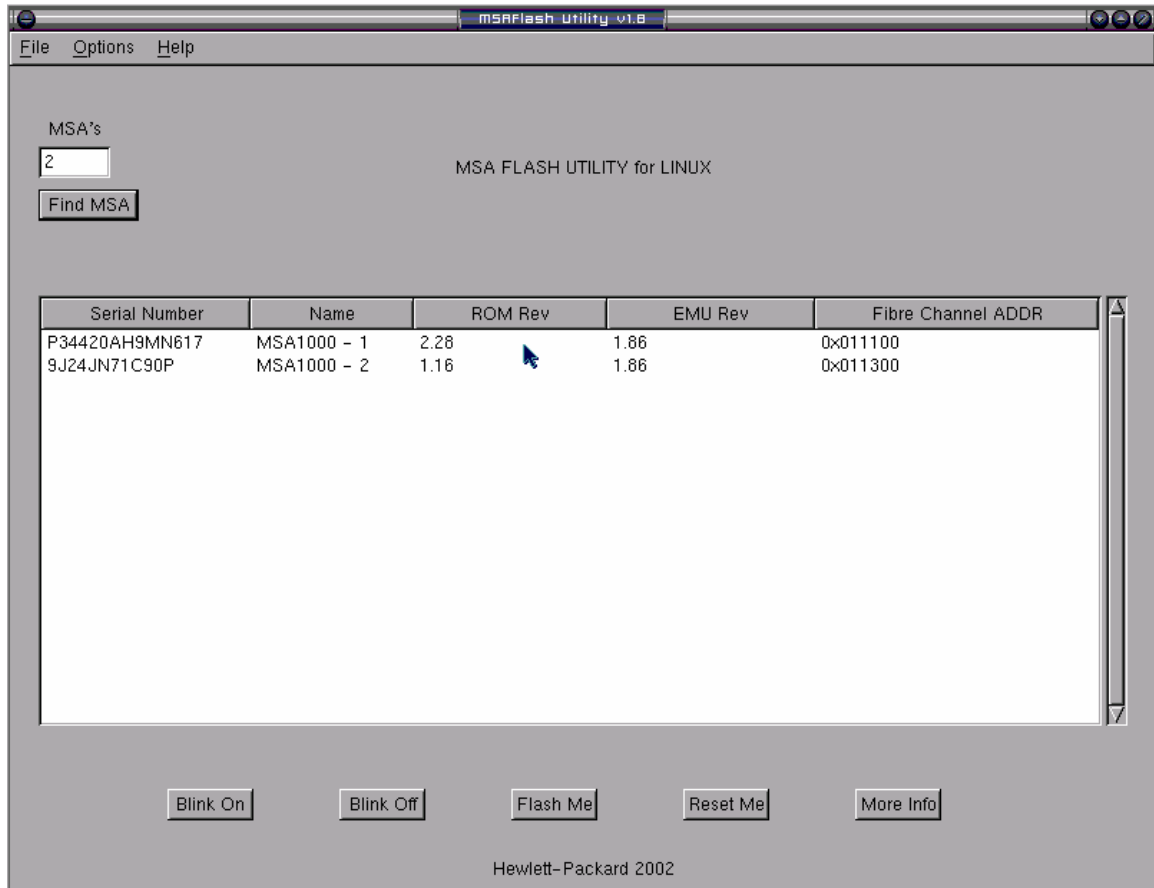

At this point, the MSA1000 firmware flash is complete. You can at this point flash the other MSA1000 controller's, EMU's (if they exist), or the MSA Fabric Switch 6 firmware. If you have no other controllers to flash, you can close the MSA1000 Firmware Flash Utility, which will cause a reboot of the server. If not flashing the MSA1000 Fabric Switch 6, please skip the next section.

Flashing the MSA1000 Fabric Switch 6 firmware

Please note – do NOT try to flash multiple switches at the same time. While the flash utility will allow you to select multiple switches, it is not advised to flash more than one switch at a time. To flash the MSA1000 Fabric Switch 6, the same CD that was created and used for the MSA1000 controller and EMU firmware flash is used.

As the MSA1000 will need a power cycle after the Fabric Switch 6 firmware upgrade, ensure that no servers are running I/O on the MSA1000.

1. Place the MSA1000 FW Upgrade CD in the servers CD ROM Drive, and power on the server. The MSA1000 Firmware Flash Utility main menu will appear after boot.

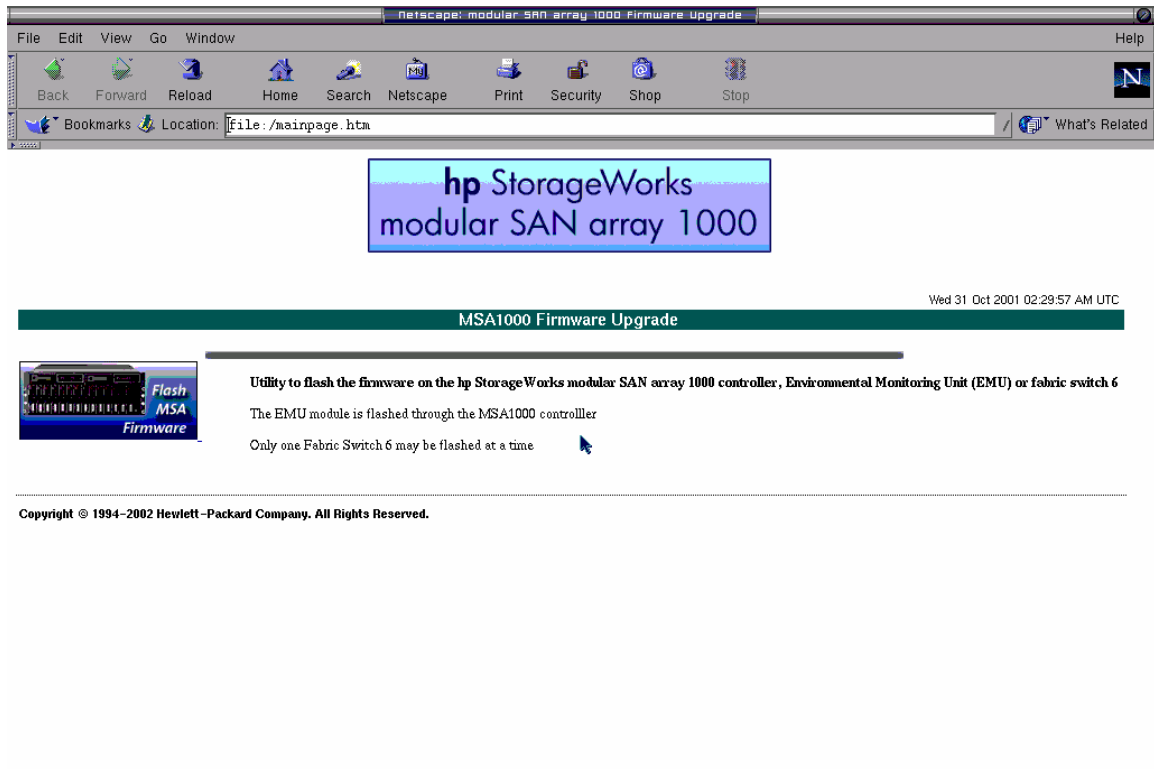

2. Select the controller that you want to flash by highlighting it with a single click.

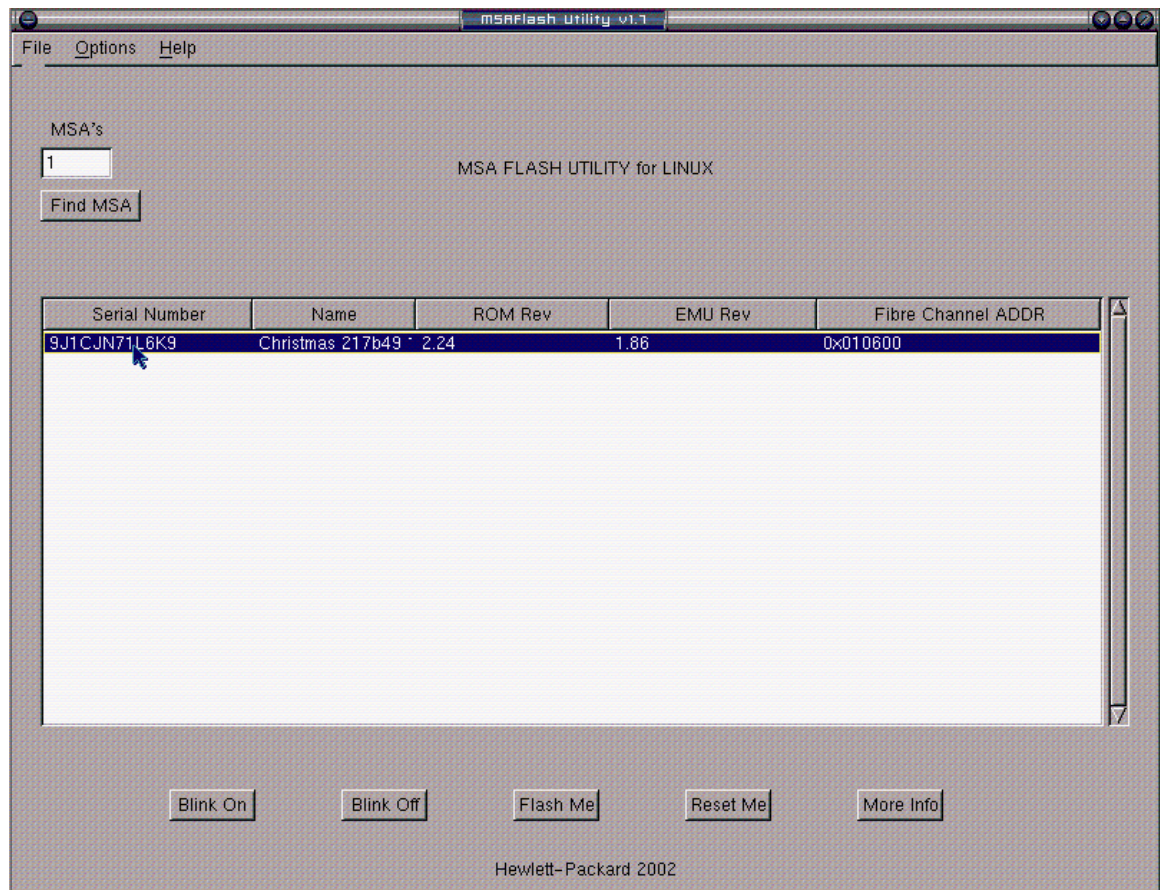

- From the pull down menu, select **Options**, then **Switches** to display the switches available for firmware upgrade

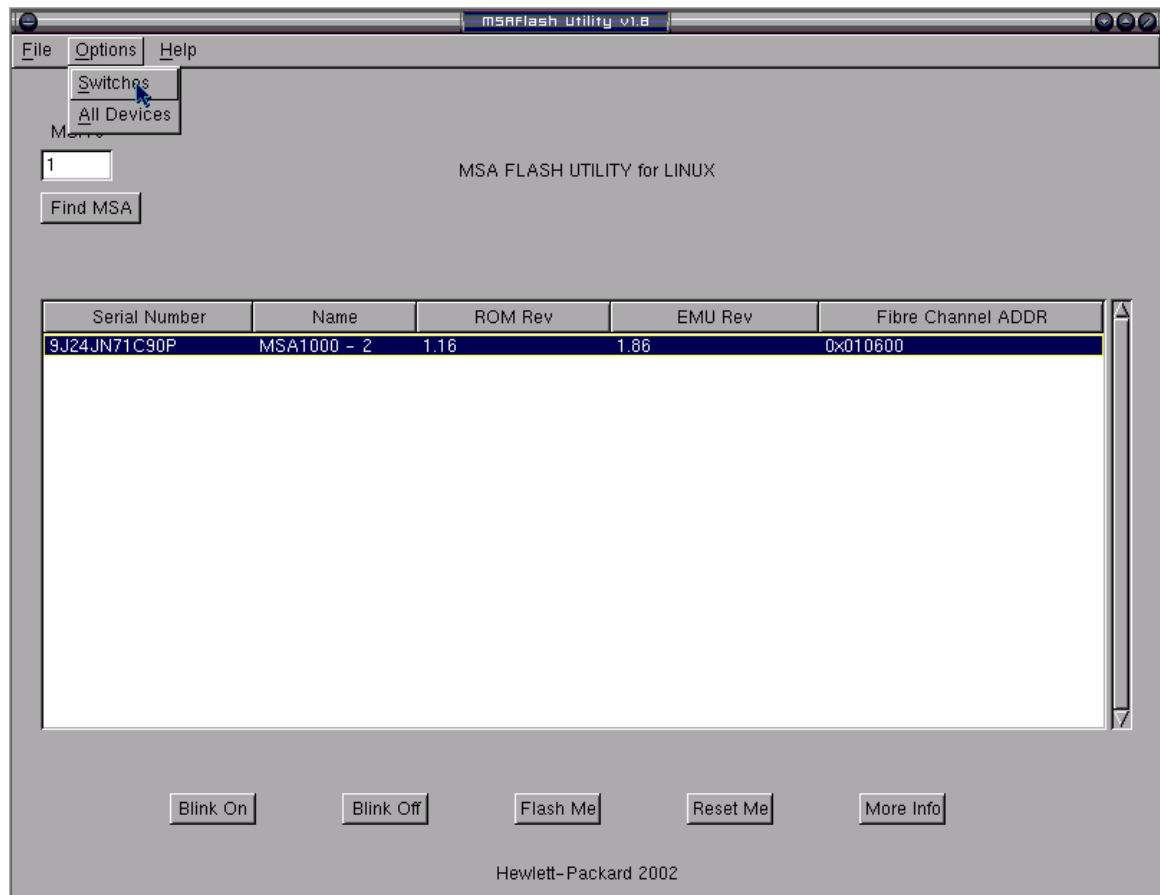

- This will display a list of available switches to flash. In this case, there is only one switch available to flash. Highlight the desired switch, and then click the **Flash** button.

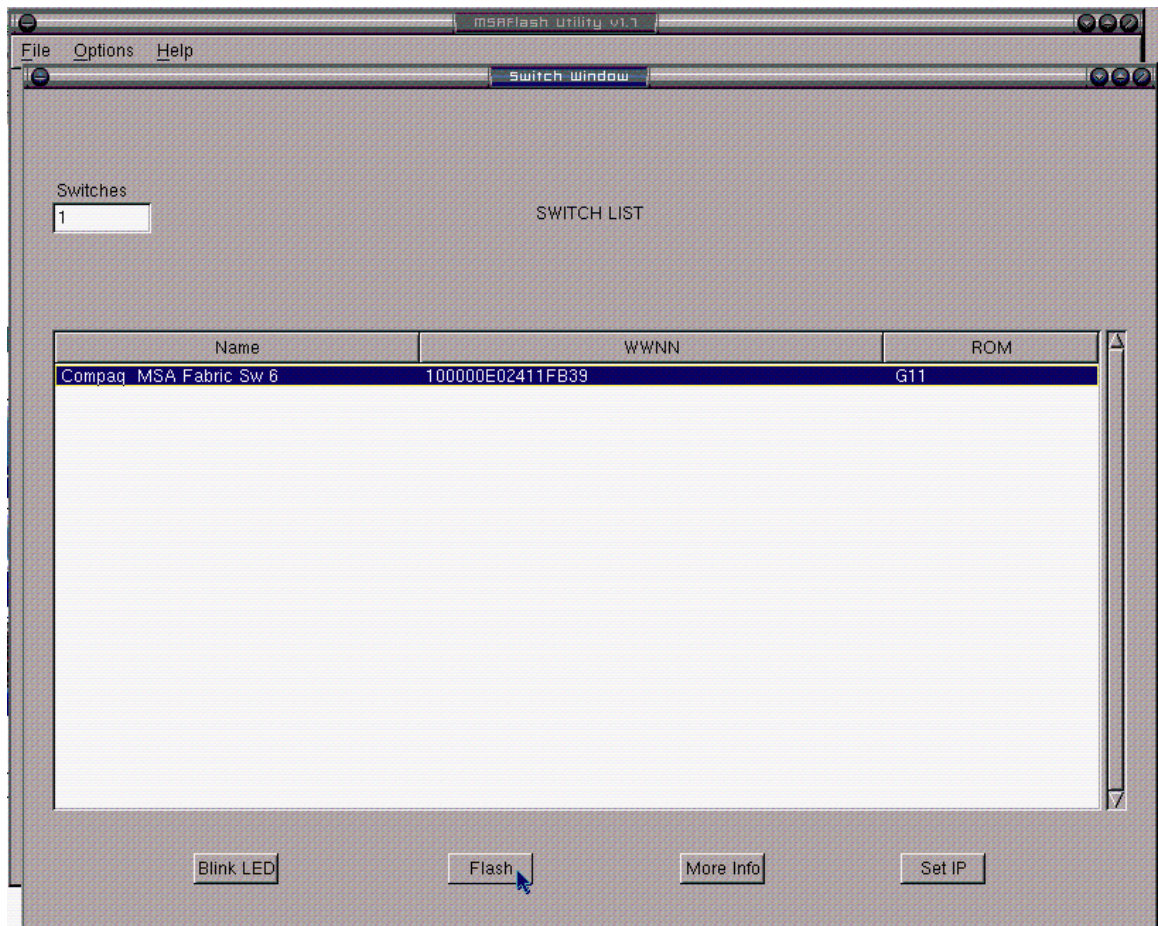

5. The next prompt is for the switch firmware upgrade source file. By default, the listing is from the CD. Highlight the firmware file (in this case CP101G12.bin), and click on the **OK** button.

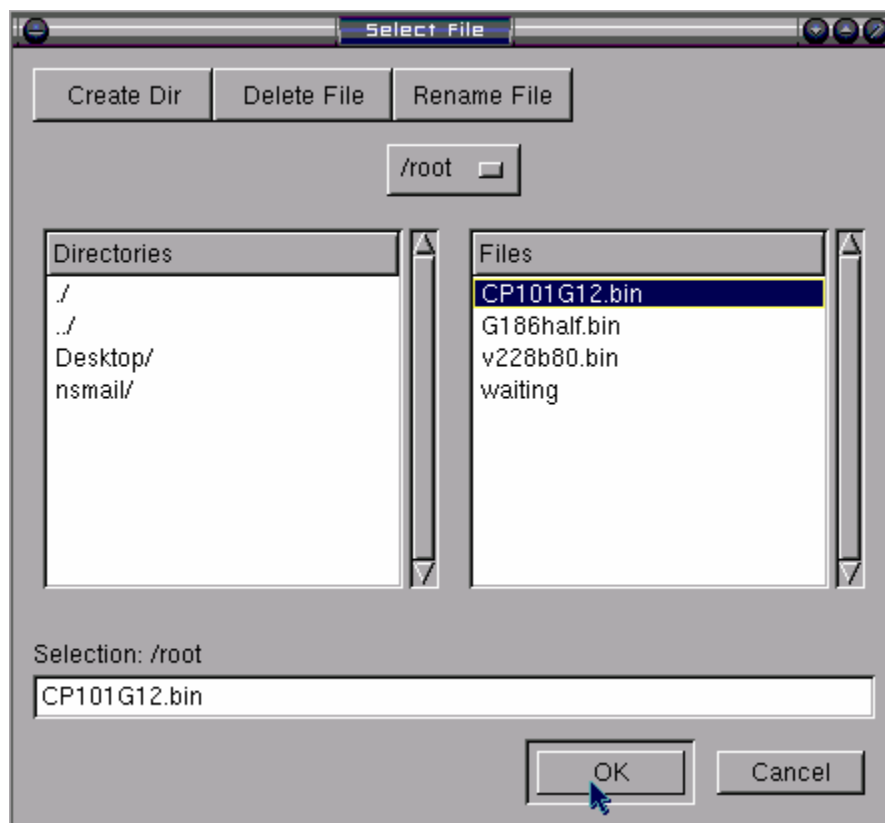

- A message will pop up explaining that the firmware flash of the embedded switch will take approximately 2 – 3 minutes. Click on **YES** to begin the firmware flash.

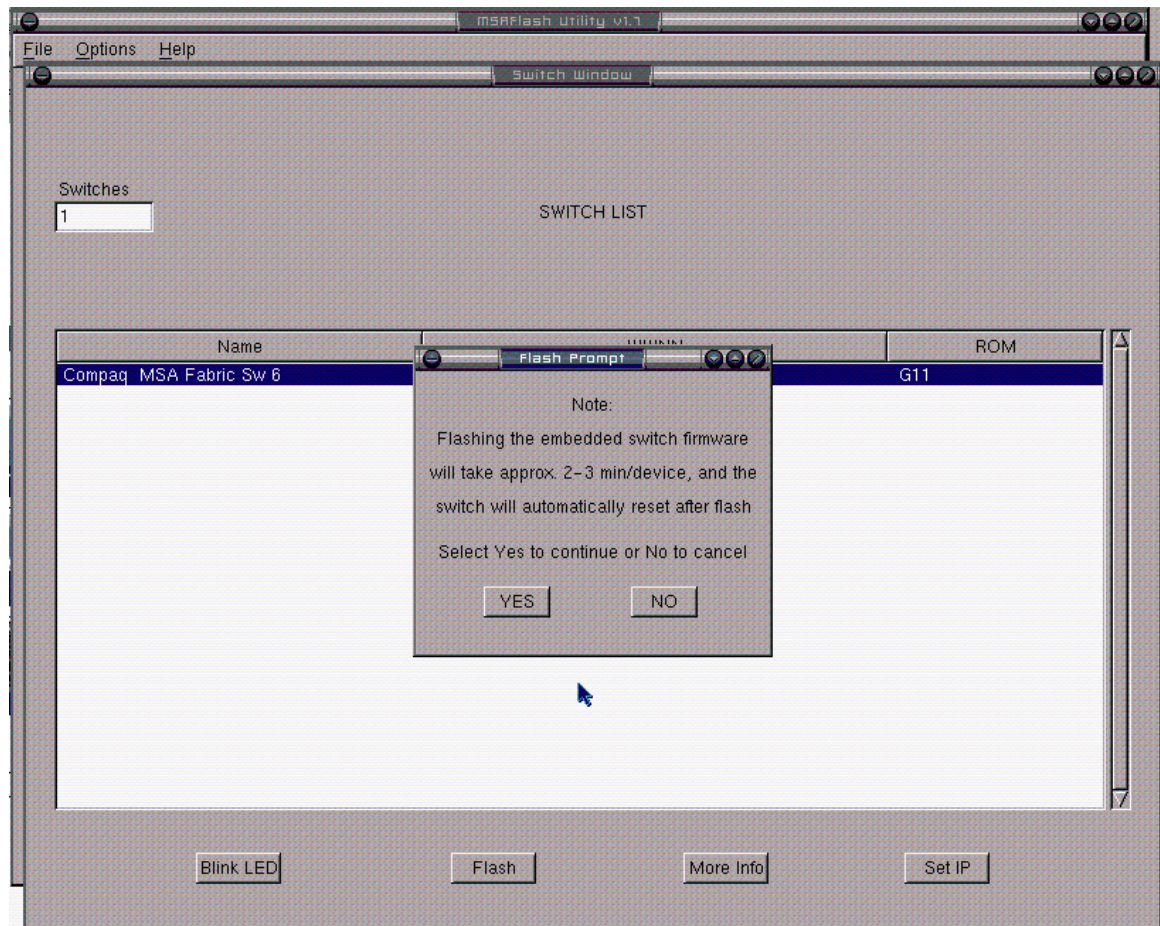

7. As the flash begins, a progress window will appear, giving status of the flash progress.

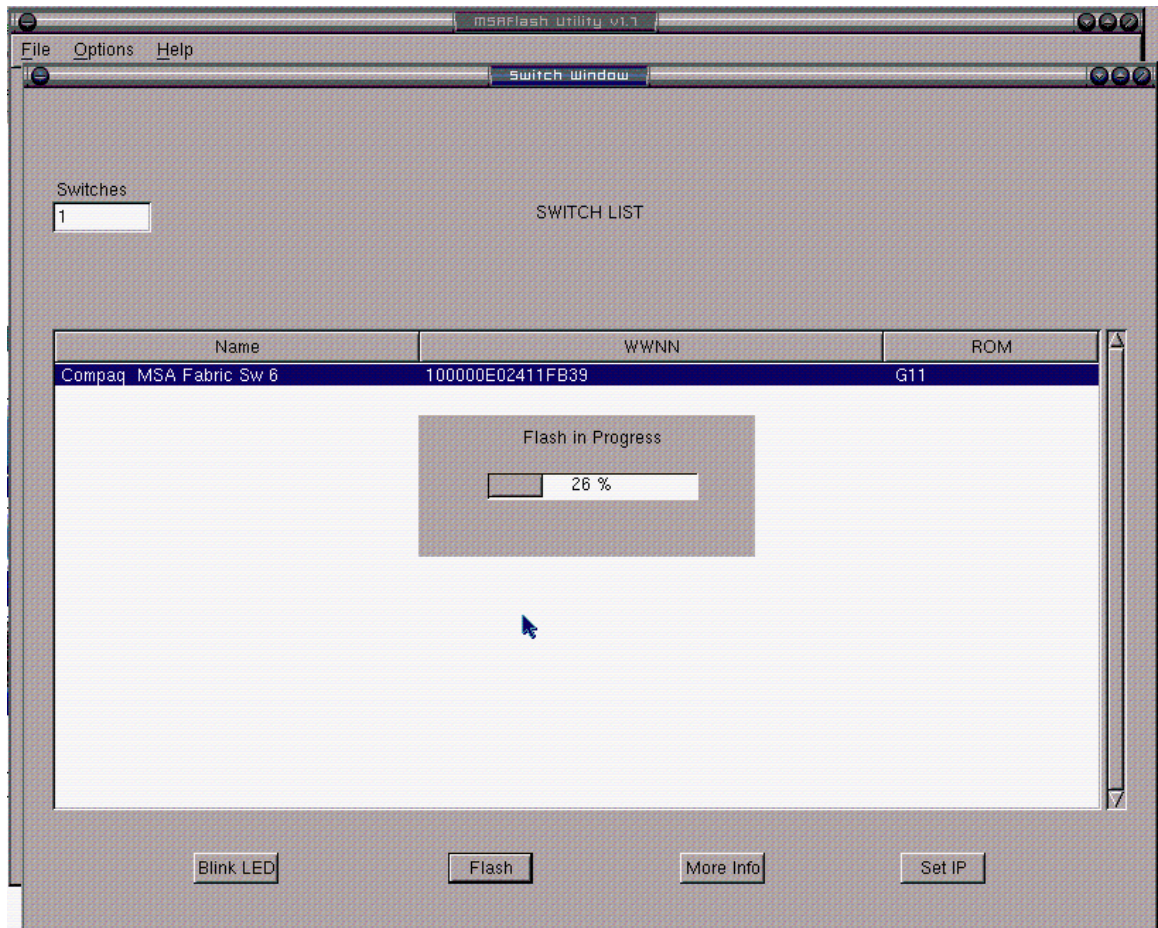

- When finished, a **Flash Successful** message appears. Close this pop up, and exit from the **Switch List** screen.

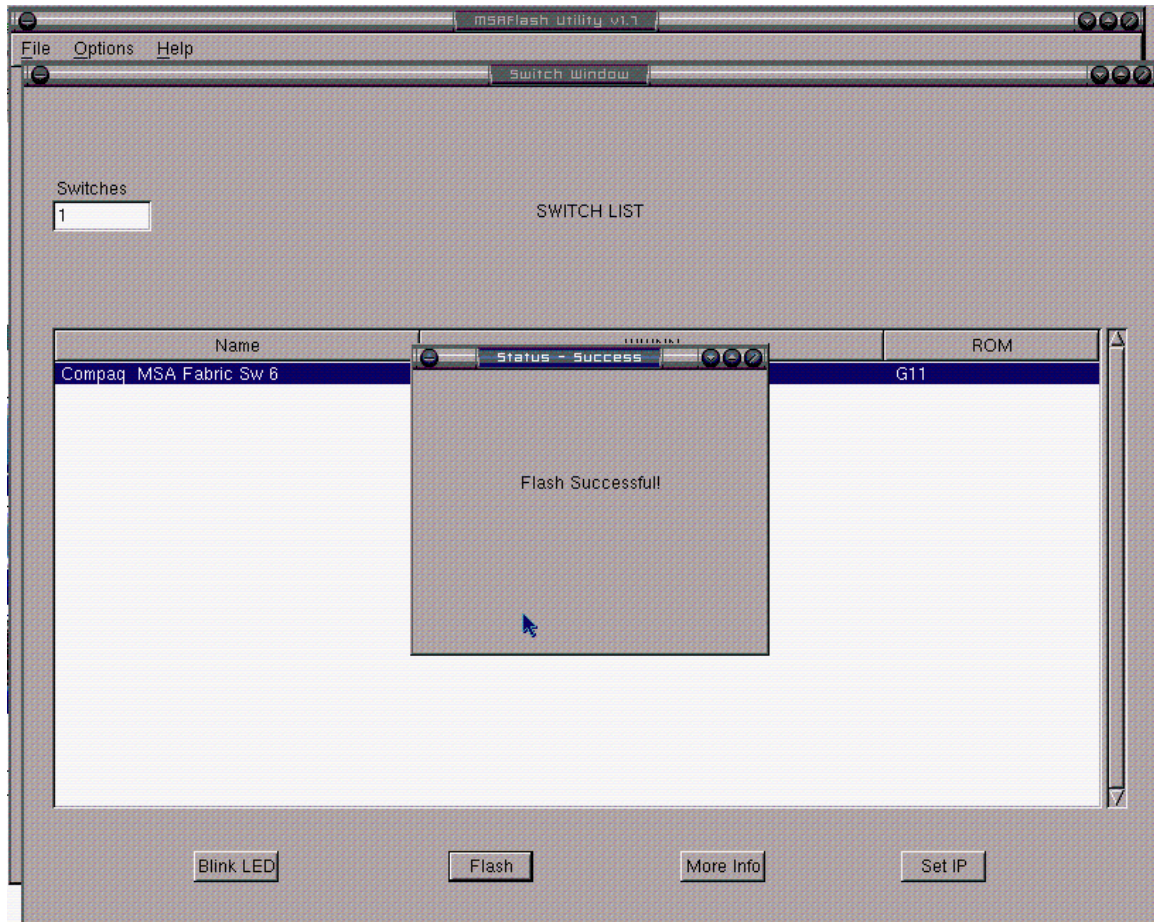

- To complete the switch firmware upgrade, the MSA1000 will have to be power cycled. The MSA1000 FW Upgrade CD can be removed from the server that performed the flash, and then shut down. Power cycle the MSA1000, and let the MSA1000 fully boot. When the MSA1000 LED screen reads:

```
01  COMPAQ MSA1000
STARTUP COMPLETE
```

The MSA1000 upgrade process has been completed. The next step is to upgrade or install the Array Configuration Utility (ACU). Please continue on to the next section for details.

Upgrading Array Controller Utility (ACU)

For Windows only Systems, place the MSA1000 Support Software CD in the server's CD ROM drive. The AUTORUN feature will display a menu of choices:

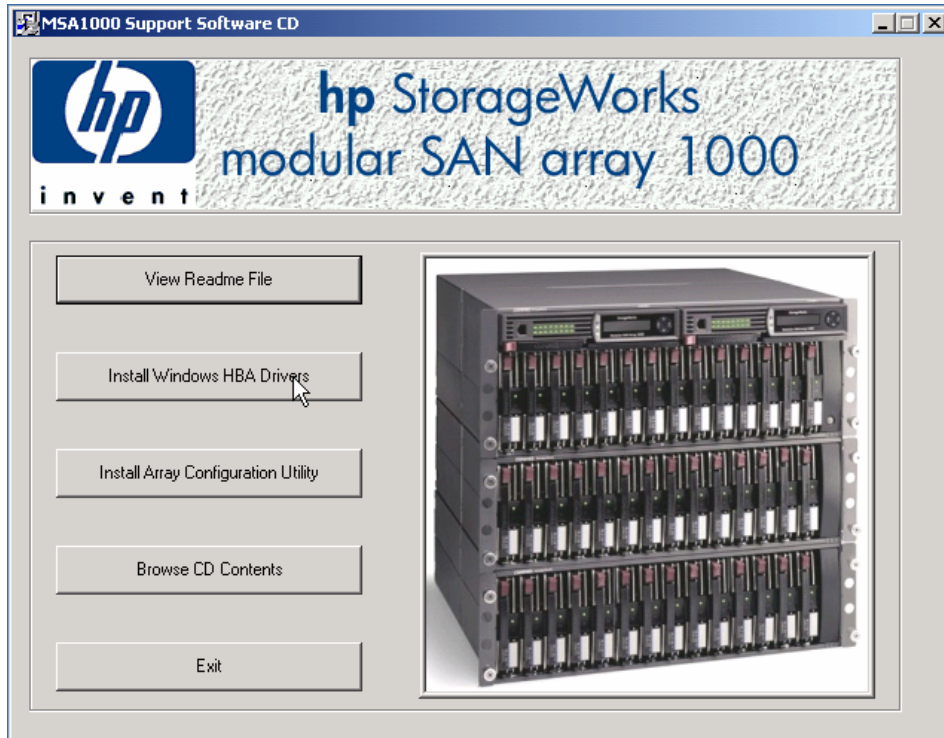

From this utility screen, click on “**Install Array Configuration Utility**”. Follow the prompts to either install or upgrade the Array Configuration Utility. If prompted to “**Reboot to Enable the Changes**”, select the option to “**Reboot Now**”.

Upgrading to Secure Path 4.0

If you were previously operating in a Secure Path 3.1B environment, please install the Secure Path 4.0 upgrade now (download available from the web). After the Secure Path 4.0 Upgrade installation, you are instructed to reboot your server. As the operating system is loading from this reboot, you should receive a message that “**Windows has detected new hardware. Please reboot for changes to take effect**”. Upon receiving this message, please perform a second reboot of the server. If you do NOT get this message after operating system load, please perform a second manual reboot of the server.

Also, it is recommended that you upgrade the HP management agents to version 5.50 or greater for better interaction with Secure Path 4.0.

Externally (SAN) Booted Configurations

If the any servers were booting from the SAN (External Boot), you will have to load the HBA Boot BIOS utility, and re-point the HBA to the Boot LUN, as the LUN numbering has changed with the MSA1000 firmware upgrade.

Please reference these whitepapers for instructions on pointing to the boot LUN:

Configuring the StorageWorks MSA1000 for external boot with Microsoft Windows

Configuring the StorageWorks MSA1000 for external boot with NetWare

Summary

The enhancements to the MSA1000 are now complete. If all pieces of the MSA1000 have been upgraded, it is safe to bring all components back on line. Follow best practices for bringing clustered pairs back on line.